



Verizon One™ User Guide



Verizon One User Guide

Table of Contents

1. Product Description	9	7. Installing the Verizon One Base Unit	18
1.1 Installation Requirements	9	7.1 Choosing a Location to Install Verizon One	18
1.2 Networking Requirements	9	7.2 Installing the Base Unit on a Desktop or Flat Surface	18
2. Conventions Used in This Document	11	7.3 Wall Mounting on a Hollow Drywall Surface (Optional)	19
3. Safety Instructions	12	8. Handset Battery	21
3.1 Safety Instructions	12	8.1 Installing the Handset Battery	21
3.2 Battery Safety Instructions	12	8.2 Parking or Charging the Handset (Battery)	22
4. Regulatory Information	13	8.3 Battery Charge Indication	23
4.1 FCC Compliance Note	13	8.4 Turning On the Handset	25
5. Getting to Know Verizon One	14	8.5 Using the Handset Belt Clip	25
5.1 Base Unit Features	14	9. Registering the Handset to the Base Unit	26
5.2 Cordless Handset Features	14	9.1 Registration Procedure	26
5.3 Touch-Screen Features	15		
6 Verizon One Set-Up	17		
6.1 Checking Kit Contents	17		



Verizon One User Guide

10. Verizon One Handset Controls	28	13. Using the Verizon One Handset Menu	41
10.1 Handset Control Buttons	28	13.1 Incoming Calls Log	43
10.2 Handset Activity LED	31	13.1.1 Place a Call	43
10.3 Backlighting	32	13.1.2 Save a Record to your Phonebook	44
11. Verizon One Handset Screens	33	13.1.3 Erase Call from the Incoming Calls Log	44
11.1 Standby	33	13.2 Ringer Setup Menu	45
11.2 No New Calls	33	13.2.1 Ringer Volume	46
11.3 New Calls	34	13.2.2 Ringer Tone (Melody)	46
11.4 Ringer Off	34	13.2.3 Keypad Tones	47
11.5 New Calls, No Messages Waiting, Line in Use	34	13.3 Handset Name Menu	47
11.6 New Calls, Messages Waiting, Line in Use	35	13.4 Date and Time Menu	48
12. Dialing Functions	36	14. Using the Handset Phonebook Menu	49
12.1 Off-Hook Dialing and Dialing Screen	36	14.1 View Your Phonebook	49
12.2 Preview or On-Hook Dialing	37	14.2 Add a New Name	50
12.3 Off-Hook & On-Hook Dialing Alternatives	38	14.3 Edit a Phonebook Entry	53
12.4 Placing a Handset Call On Hold	38	14.4 Erase a Phonebook Entry	55
12.5 Redial	39	14.5 Place a Call	55
12.6 Incoming Call Screen	39		
12.7 Call Waiting Screen	40		



Verizon One User Guide

15. Using Intercom and Call Transfer Functions 56

15.1 Intercom Functions	56
15.1.1 Paging the Base	56
15.1.2 No Answer From a Page	57
15.1.3 Using the Intercom During an Active Call	57
15.2 Call Transfer Functions	58
15.2.1 Completing a Call Transfer	58
15.2.2 Call Back	59
15.3 3-Way Conferencing	59
15.3.1 3-Way Conference	60
15.4 Handset Locator	60
15.5 Out-of-Range Detection	61

16. Headset Support 62

17. Verizon One Base Unit Controls 63

17.1 Base Speakerphone Control Buttons	63
17.2 Base Activity LED	65

18. Verizon One Base Unit Operations 67

18.1 Base, Stylus and Touch-Screen	67
------------------------------------	----

18.2 Making and Ending Calls	67
18.3 Answering Incoming Calls	68
18.4 Transferring Calls from the Base to the Handset	68
18.5 Transferring Calls from the Handset to the Base	68
18.6 Paging from the Base	69
18.7 Adjusting the Volume	69
18.8 Using the Mute Button	69
18.9 Using the Hold Button	70
18.10 Using the Menu and Address Book Buttons	70

19. Touch-Screen Features 71

19.1 Touch-Screen Navigation	71
19.1.1 Menu	72
19.1.2 Touch-Screen Keyboard and Numeric Keypad	74
19.1.3 Incoming Calls, Outgoing Calls and Voice Mail Logs	74
19.1.4 Call Log Features	75
19.1.4.1 View Caller	75



Verizon One User Guide

19.1.4.2 Update a Contact	76	19.6.3 Appointments	85
19.1.4.3 Map a Caller	76	19.6.3.1 Add an Appointment	85
19.1.5 Receiving an Incoming Call	77	19.6.3.2 Edit an Appointment	86
19.1.6 Placing an Outgoing Call	78	19.6.3.3 Delete an Event	86
19.2 Voice Mail	79	19.6.4 Tasks	87
19.3 Speed Dial	79	19.6.4.1 Add a Task	87
19.3.1 Add a Contact to Your Speed Dial List	79	19.6.4.2 Edit a Task	87
19.3.2 Edit a Contact on Your Speed Dial List	80	19.6.4.3 View Tasks	88
19.3.3 Dial a Contact on Your Speed Dial List	80	19.7 Memos	88
19.4 Emergency Numbers	80	19.7.1 Memo Screen	88
19.4.1 Add an Emergency Number	80	19.7.2 View a Memo	88
19.4.2 Edit an Existing Emergency Number	80	19.7.3 Add a Memo	88
19.5 Address Book	81	19.9 SuperPages	90
19.5.1 Calling a Contact from your Address Book	81	19.9.1 Look Up a Business	90
19.5.2 Get Address, Map and Directions	82	19.9.2 Look Up a Person	91
19.5.3 Adding Contacts to Your Address Book	82	19.9.3 Reverse Lookup	91
19.5.3.1 Add a Person	82	19.9.4 Search Results	92
19.5.3.2 Delete a Person	83	19.9.4.1 SuperPages - Map	92
19.5.3.3 Add a Business Contact	83	19.9.4.2 Add a SuperPages Search Results Number to Your Address Book	93
19.5.3.4 Add a Group	84	19.10 E-mail	93
19.6 Calendar	84	19.10.1 Setup E-mail	93
19.6.1 Access Your Calendar	84	19.10.2 Check E-mail	94
19.6.2 View Your Calendar	84		



Verizon One User Guide

19.10.3 Reply to an E-mail	94	19.13.1.11 Restaurants	99
19.11 Alarm/Timer	94	19.13.1.11.1 Lookup Restaurants	99
19.11.1 Start Timer	94	19.13.1.11.2 Change Cuisine	99
19.11.2 Set Alarm	94	19.13.1.11.3 Change Location	99
19.11.3 Start Stopwatch	95	19.13.1.11.4 Restaurants Near Me	99
19.12 Calculator	95	19.13.1.12 Horoscopes	100
19.13 News & More	95	19.14 Add iobiSM Home*	100
19.13.1 Choose Content	95	19.14.1 Manage Calls	100
19.13.1.1 My Choices	95	19.14.1.1 Using Manage Calls	101
19.13.1.2 Top Headlines	95	19.14.1.2 Manage Call Forwarding Destination (Phone Numbers)	102
19.13.1.3 Movies	96	19.14.2 Voice Mail	102
19.13.1.4 Weather	96	19.14.2.1 Play Messages	102
19.13.1.4.1 Local Weather	96	19.14.2.2 Forward Messages	102
19.13.1.4.2 Radar	97	19.14.2.3 Schedule Call Forwarding	103
19.13.1.4.3 International Weather	97	19.14.2.4 Edit Call Forwarding	104
19.13.1.5 Sports News	97	19.15 Phone Tips	105
19.13.1.6 Scores	97	19.16 Settings	105
19.13.1.7 Entertainment	97	19.16.1 Date/Time	105
19.13.1.8 Lottery	98	19.16.2 Screen Saver	105
19.13.1.8.1 View Game	98	19.16.3 Display	106
19.13.1.8.2 Change Location	98	19.16.4 Voice Mail*	106
19.13.1.9 Stocks	98	19.16.5 Cell Phones	106
19.13.1.10 SuperPages	98		



Verizon One User Guide

19.16.5.1	Manage Cell Phones	106	20. Home Networking	111	
19.16.5.2	Add Cell Phones	107	20.1	What is Home Networking	111
19.16.5.2.1	Authorizing a Cell Phone	107	20.2	Important Information About Your Verizon One Home Network	111
19.16.5.3	View Cell Phone	107	20.3	Installing Your Verizon One Home Network	112
19.16.6	Home Networking	107	20.3.1	Home Networking System Requirements	113
19.16.7	Ring Tones	108	20.3.2	LED Indicators	114
19.16.7.1	Set Ring Tone	108	20.3.3	Interface Descriptions	117
19.16.7.2	View Ring Tones	108	20.3.4	Installing a Wired Network	118
19.16.8	Volume	108	20.3.5	Installing a Wireless Network	120
19.16.9	Handsets	109	20.3.6	Installing Both a Wired and Wireless Network Simultaneously	122
19.16.9.1	Name Handsets	109	20.4	Accessing Configuration Settings	122
19.16.9.2	Register Handsets	109	20.5	Authenticate User	132
19.16.9.3	Edit Handsets	109	20.6	Password Protection	132
19.16.10	Shortcuts	110	20.7	Configure Wireless Settings	133
19.16.10.1	View Shortcuts	110	20.7.1	Setup Wireless Network	133
19.16.10.2	Choose Shortcuts	110	20.7.2	Setup Wireless Security	133
19.16.12	System Info	110	20.8	Manage Security	134
			20.8.1	Change Firewall	134
			20.8.2	Add Services	134
			20.8.3	Manage Services	134



Verizon One User Guide

20.8.4	View Services	135
20.8.5	View Clients	135
20.9	Setup My Connection	135
20.9.1	Setup FiOS Connection	135
20.9.2	Setup DSL Connection	135
21.	Technical Support	136
21.1	Getting Help	136
21.1.1	Touch-Screen Help	136
21.1.2	Help with Your DSL Service	136
21.1.3	Helpful Web Sites	137
21.1.4	Important Troubleshooting Tips	137
21.1.5	Contact Us	137
21.1.6	Automatic Software Updates	137
21.1.7	Verizon One Customer Notifications	138



Verizon One User Guide

1. Product Description

1.1 Installation Requirements

To install **Verizon One**, you will need the following:

A Network Interface Card (NIC) installed in your PC, or an IEEE 802.11b/g adapter.

NOTE: Please wait until you have received notification from **Verizon One** that your DSL line has been activated before installing the Communications Subsystem of your **Verizon One**. You may, however, install your **Verizon One** prior to the availability of DSL service to your line.

1.2 Networking Requirements

The following system specifications are required for optimum performance of **Verizon One** via 10/100 Base-T Ethernet or Wireless installations:

Connection Type	Minimum System Requirements
Ethernet	<ul style="list-style-type: none"> • Pentium® or equivalent and above class machines, Macintosh® • Microsoft® Windows® (95, 98, 2000, ME, NT 4.0, or XP), Macintosh® OS X, or Linux installed • Computer Operating System CD-ROM on hand • Internet Explorer® 4.x or Netscape® Navigator® 4.x or higher • 64 MB RAM (128 MB recommended) • 10 MB of free hard drive space • TCP/IP Protocol stack installed • 10/100 Base-T Network Interface Card (NIC)
Wireless IEEE 802.11g	<ul style="list-style-type: none"> • Pentium® or equivalent and above class machines • Microsoft® Windows® (98, ME, 2000, or XP) or Macintosh® OS X installed • Computer Operating System CD-ROM on hand • Internet Explorer® 4.x or Netscape® Navigator® 4.x or higher • 64 MB RAM (128 MB recommended) • 10 MB of free hard drive space • An available IEEE 802.11b/g/g+ PC adapter



Verizon One User Guide

1. Product Description

1.2 Networking Requirements (*cont'd*)

NOTE: Before you connect via 10/100 Base-T, you must have an available Ethernet card installed in your computer. If your Ethernet card does not auto-negotiate, you must set it to half duplex. Refer to the Ethernet card manufacturer's instructions for installing and configuring your Ethernet card.

NOTE: PCs can use any Wireless Fidelity (Wi-Fi) 802.11b/g/g+ certified card to communicate with **Verizon One**. The Wireless card and **Verizon One** must use the same Wired Equivalent Privacy (WEP) security code type. The factory default for WEP is DISABLED. If you enable WEP, you must ensure the network setting for your wireless adapter is set to "Must Use Shared Key for WEP" or "Open Wi-Fi." You must ensure that your PC's Wi-Fi adapter is configured properly for

whichever network setting you use. You can access the settings in the advanced properties of the wireless network adapter.

Verizon One can function in two modes: The first mode, called the **Standalone Mode**, occurs when **Verizon One** IS NOT CONNECTED to active DSL service. In this mode, **Verizon One** provides traditional, standard cordless telephone functionality that can be used in your home/office, as explained in this document.

The second mode, called the **Active Mode**, occurs when **Verizon One** IS CONNECTED to active DSL service. In this mode, **Verizon One** provides additional voice and data services through your high-speed Internet connection that are accessible from the touch-screen display (such as Address Book and

Calendar functionality). For details on how to use these additional features and navigate the touch-screen display, please see **Verizon One** applications and tools.



Verizon One User Guide

2. Conventions Used in This Document

- **LCD Screens:** The screens displayed in this document are meant to provide a visual representation of **Verizon One's** Handset and Base functionality. The actual data displayed in your LCD screens may differ slightly from the data displayed in the screens of this document.
- **Note:** Refers to outlined information that provides additional details about a feature or function.
- **On-Hook:** Refers to the condition when either the Base Unit or Handset is not active in requesting a dial tone or placing a call.
- **Off-Hook:** Refers to the condition when either the Base Unit or Handset is active in requesting a dial tone or is engaged in a call.
- **Pointer:** Refers to the pointer symbol ► used to select items in the LCD screens.
- **Screen:** Refers to either the Handset's or the Base Unit's Liquid Crystal Display (LCD).
- **Words Enclosed in Symbols:** < > represent physical buttons that you can press with your finger. These are located on the face of the Handset and the Base Unit.
- **Words Enclosed in Brackets:** [] represent soft key functions accessible/selectable through Handset and Base LCD screens.



Verizon One User Guide

3. Safety Instructions

3.1 Safety Instructions

- Never install any telephone wiring during a lightning storm.
- Never install telephone jacks in wet locations unless the jack is specifically designed for a wet location.
- Never touch non-insulated telephone wires or terminals unless the telephone line has been disconnected at the network interface.
- Use caution when installing or modifying telephone lines.
- Avoid using during a lightning storm.
- Do not use while wet or while standing in water. Do not place **Verizon One** near water, such as near a sink or bath tub.
- Unplug **Verizon One** from the wall outlet and telephone jack before cleaning. Only use a soft, damp cloth to clean **Verizon One**. Do not use chemicals or cleaning agents.

- Use only the Power Adaptor that came with **Verizon One**.

IMPORTANT: In the event of a loss of electricity to your home/office, your **Verizon One** system will not operate. For this reason, it is recommended that you have at least one standard telephone in your home/office for use in case of an emergency.



WARNING

Risk of electric shock. Voltages up to 140 Vdc (with reference to ground) may be present on telecommunications circuits.

3.2 Battery Safety Instructions

- Use only the battery that was provided with your **Verizon One** kit, or an authorized replacement recommended by the manufacturer.
- Do not puncture the battery. The battery contains toxic materials that could be released if mishandled, resulting in injury.
- Keep batteries and other potentially hazardous devices out of the reach of children.
- Never dispose of batteries in fire, which could result in an explosion.



Verizon One User Guide

4. Regulatory Information

4.1 FCC Compliance Note

This equipment has been tested and found to comply with the limits for a Class B digital device, pursuant FCC Statement: This Product has been tested and found to comply with the limits for a Class B digital device, pursuant to part 15 of the FCC Rules. These limits are designed to provide reasonable protection against harmful interference in a residential installation. This Product generates, uses, and can radiate radio frequency energy and, if not installed and used in accordance with the instructions, may cause harmful interference to radio communication. However, there is no guarantee that interference will not occur in a particular installation. If this Product does cause harmful interference to radio or television reception, which can be determined by turning the Product off and on, the

Customer is encouraged to try to correct the interference by one or more of the following measures:

- Reorient or relocate the receiving antenna.
- Increase the separation between the Product and receiver.
- Connect the Product into an outlet on a circuit different from that to which the receiver is connected.
- Consult **Verizon Online** or an experienced radio/TV technician for help.



Verizon One User Guide

5. Getting To Know Verizon One

5.1 Base Unit Features

The following features are provided in the **Verizon One** Base Unit. An in-depth description of functions will be discussed later in this document:

- Symmetrical 5.8 GHz DSS cordless telephone technology with built-in 5.8 GHz Antennae
- 75 Hopping Channels for enhanced operation under interference
- 12-key Keypad allows alphanumeric data entry to the Base
- Control buttons which allow set-up, navigation, menu selection, and call control (such as Hold, Mute, Intercom, Volume Control) from the Base
- Full Duplex, Hands-free Speaker/Microphone for placing and receiving calls from the Base

- Internally filtered convenience/fax jack – enables the connection of other telephony equipment, such as fax machines, directly to **Verizon One**
- Integrated Handset Cradle with Battery Charger
- Illuminated, Color LCD touch-screen – Primary user interface that enables access to **Verizon One's** advanced services
- LED Indicators display the operational status of **Verizon One's** telephony and data networking functions
- Message Waiting/Ringing LED indicator – provides indication of incoming calls and/or message waiting
- Selective intercom page to either Base or the Handset
- Stylus functions as a detachable, pen-like, plastic tool for selecting items on the Base touch-screen

5.2 Cordless Handset Features

The following features are provided in the **Verizon One** Cordless Handset. An in-depth description of functions will be discussed later in this document:

- Symmetrical 5.8 GHz DSS cordless telephone technology with built-in 5.8GHz Antenna
- 75 Hopping Channels for enhanced operation under interference
- Illuminated 12-key Keypad allows alphanumeric data entry
- Control buttons which allow set-up, navigation, menu selection, and call control (such as Hold, Mute, Intercom, Manual Volume Control) from the Handset
- Illuminated Liquid Crystal Display (LCD) screen with graphics-based operation



Verizon One User Guide

5. Getting To Know Verizon One

5.2 Cordless Handset Features (cont'd)

- Message Waiting/Ringing LED indicator—provides indication of incoming calls and/or message waiting
- Caller ID***, Call Waiting**** and Call Waiting with Caller Line ID
- Incoming Calls with the last 40 Caller ID records
- Support for Off-Hook dialing, pre-dialing and redial
- One-touch conference and Selective intercom page between Base and Handset
- Phonebook dialing; up to 50 entries
- Redial from list of last 5 numbers dialed
- Saving Selective Caller ID records into Phonebook directory
- Digital Volume Control

- Rechargeable Battery
- Ear Plug Adapter for headset (optional headset not included)
- Belt Clip for hands-free operation when using a headset (optional headset not included)

*Display of these features requires your DSL service to be active. Once your Service Ready Date has arrived, and **Verizon One** detects an active DSL connection - these features will automatically appear.

**Available to Verizon Home Voice Mail subscribers only.

***Caller ID subscription is required.

****Call Waiting subscription is required.

5.3 Touch-Screen Features

The following features are accessible via the **Verizon One** touch-screen. See Section 19: Touch-Screen Features for more information on each of the following:

- Calls
- Voice Mail**
- Speed Dial
- Emergency Numbers
- Address Book*
- Calendar*
- Memos
- SuperPages*
- Calculator
- News & More*



5. Getting To Know Verizon One

5.3 Touch-Screen Features (cont'd)

- Upgrade to **iobism Home***

See section 19.12 for more information on **iobi Home** and each of these features:

- Call Forwarding**
 - On-screen Voice Mail***
 - Manage Calls
 - **iobi Home** on Your Desktop
 - **iobi Home** on the Web
-
- Verizon Customer Notifications
 - Automatic Software Updates

***iobi Home** provided by Verizon Long Distance ("Verizon") and subject to terms and conditions. ***iobi Home** is not currently compatible with Macintosh® computers. Verizon is not responsible for messages that are lost or delayed due to transmission via the Internet. Information sent via the Internet, including E-mail and Text Messages, is not secure and may be intercepted by third parties during transmission. Verizon is not responsible for the content of messages sent via the E-mail feature. **iobi Home** may not be used for any unlawful purpose, such as sending unsolicited commercial E-mail messages (e.g., spamming). Recipient is responsible for the cost of receiving Text Messages, if any. Taxes and other charges apply.

**Charges for forwarded calls will be billed by the carrier that carries the forwarded calls. Calls may not be forwarded to an international number.

***You must subscribe to a compatible version of Verizon Home Voice Mail (sold separately) to access Voice Mail features of **iobi Home**.



Verizon One User Guide

6. Verizon One Set-Up

6.1 Checking Kit Contents

Your kit contains everything you need to set-up **Verizon One** and install your Verizon Online DSL service if you are a new subscriber.

1. **Verizon One** Base Unit with Display
2. **Verizon One** Base Unit Swivel Support Stand
3. Cordless Telephone Handset with Battery
4. Handset Belt Clip
5. Stylus
6. Power Adaptor and Cord
7. RJ-11 Gray Phone Cord
8. RJ-45 Yellow Ethernet Cable
9. DSL Installation CD
Verizon One will instruct you when to insert into your computer.
10. DSL Filter Kit
The DSL Installation CD will instruct you on where and how to install filters. Filter Kit only included for new DSL subscribers.
11. **Verizon One** Important Product Information (not pictured)
12. Verizon Online DSL Resource Guide (not pictured)





Verizon One User Guide

7. Installing the Verizon One Base Unit

7.1 Choosing a Location to Install Verizon One

For optimal performance of **Verizon One**, choose a location that is:

- Away from active electrical areas
- Away from interference such as a television, radio or microwave oven
- Away from water or moisture, excessive dust, or extreme cold
- Away from heat sources and sunlight
- In a central location that has no obstructions—this will optimize cordless performance
- Separate from another **Verizon One** Base Unit

7.2 Installing the Base Unit on a Desktop or Flat Surface

Step 1

Attach the **Verizon One** Base Unit to the Swivel Support Stand (Figure 1).

Snap the **Verizon One** Base Unit Swivel Support Stand onto the back of the Base Unit. Locate a sturdy, flat surface, table or desktop near an active wall AC power outlet, an active telephone jack and your primary computer.



Figure 1

Step 2

Plug in the Power Cord (Figure 2).

Connect the DC 12V power supply cord to the power connector marked 12V DC on the rear panel of the **Verizon One** Base Unit. Plug the other end of the power supply into an AC wall socket, and then turn on the power switch (if it is not on already). Check the Base to see if the Power LED is solid green. If the Power LED is solid green, **Verizon One** power is on.



Power is On



Figure 2



Verizon One User Guide

7. Installing the Verizon One Base Unit

7.2 Installing the Base Unit on a Desktop or Flat Surface (cont'd)

Step 3

Follow the Instructions on the **Verizon One** Display (Figure 3).

The **Verizon One** display will walk you through the necessary steps to complete the set-up of **Verizon One** and the installation of your Verizon Online DSL Service (if required).

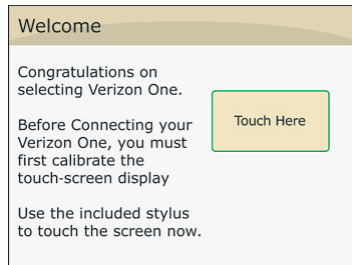

Figure 3

7.3 Wall Mounting on a Hollow Drywall Surface (Optional)

Follow the steps below to mount **Verizon One** on a wall:

NOTE: The hardware needed to wall mount **Verizon One** is not included with the product.

1. Obtain two #8 pan-head screws and two #8 wall anchors.
2. Place the **Verizon One** Base Unit stand against the wall where it is to be mounted. Using a pencil, mark one of the two corresponding screw locations. Mark the other at the appropriate distance vertically.
3. Drill a 3/16" hole for the wall anchors and insert. Screw in the #8 screws until the face of the screws are approximately 1/8" from the wall.

4. Test-fit the **Verizon One** Base Unit swivel stand on the screws and adjust the screw depth for a sliding fit. Once the stand fits tightly against the wall, remove it from the wall.
5. Connect the phone cable (included) from the jack marked DSL on the rear panel of the Base Unit to the telephone wall jack provisioned for DSL and phone service. This connection will provide dial tone for voice services in addition to providing DSL to your **Verizon One**. (**Note:** **Verizon One** has a Fax Jack that can be used to connect additional telephone equipment such as a fax machine).



Verizon One User Guide

7. Installing the Verizon One Base Unit

7.3 Wall Mounting on a Hollow Drywall Surface (Optional) (cont'd)

6. Connect the DC 12V power supply cord to the power connector marked 12V DC on the rear panel of the **Verizon One** Base Unit. Plug the other end of the power supply into an AC wall socket, and then turn on the power switch (if it is not already on).
7. Check the Base to see if the Power LED is solid green. If the Power LED is solid green, the **Verizon One** Base is powered up.
8. Verify telephone operation by pressing the <Speakerphone> button found on the front of the Base Unit. Once pressed, the In-Use LED should be solid blue and a dial tone should be heard from the speaker.
9. Once telephone operation has been verified, snap the Base Unit

Swivel stand onto the base. Adjust the stand by pressing the paddle and tilting the base until the top of the Base Unit touches the edge of the circular stand. The Base Unit must be installed in this position. Prior to placing the Base Unit and Swivel Stand onto the wall, use the cable management grooves within the bottom of the stand to guide the Power and telephone cables, so that the stand can sit flush with the wall. Mount the unit to the wall.

10. Once the unit has been mounted to the wall, re-verify telephone operation by pressing the <Speakerphone> button on the front of the Base unit. Once pressed, the In-Use LED should be solid blue and a dial tone should be heard from the speaker.



Verizon One User Guide

8. Handset Battery

8.1 Installing the Handset Battery

IMPORTANT: Before you install or handle the battery, please read Section 3.2 for Battery Safety Instructions.

Remove the battery cover by pressing and sliding the cover off the battery compartment. Attach the battery cable connector to the connector socket inside the battery compartment, and then slide the battery into the compartment.

(**Note:** Prior to replacing the battery cover, be sure that the battery cables will not obstruct the compartment when the cover is replaced.) Replace the battery cover by sliding the cover upward until it snaps into place on the Handset.

Note: Prior to using your **Verizon One** Handset for the first time, the Handset battery must be fully charged. See Section 8.2 Parking or Charging the Handset (Battery) for instructions.





Verizon One User Guide

8. Handset Battery

8.2 Parking or Charging the Handset (Battery)

Prior to using your **Verizon One** Handset for the first time, the Handset Battery must be fully charged. To charge the Handset, place the Handset into the cradle with the keypad face down so that the contacts on the Handset touch the contacts on the Base Unit. Allow the battery to charge for approximately 12 hours prior to initial use. During normal operation when the Handset is not in use, park the Handset (face down) into the Base Unit with contacts touching. This will maintain your Handset's charge.

Note: To charge the Handset initially, allow the Handset and battery to charge for 12 hours. Whenever the Handset battery needs recharging, the battery icon on the Handset's LCD will flash.

```

11:23AM JUL 28
Press OK
to register
handset
OK                               Exit
  
```

Handset
Contacts

```

11:23AM JUL 28
Press and hold
Intercom key
on Base
                               Exit
  
```

Base Unit
Contacts

```

11:23AM JUL 28
Verizon One
Registered
                               Exit
  
```

Slide the Handset face down into the cradle of Base so that the contacts touch.



Verizon One User Guide

8. Handset Battery

8.3 Battery Charge Indication

The Handset provides 4 indicator levels of the battery charge state. (Full, High, Medium, Low). It takes approximately 2 seconds for the Handset to detect the battery charge level after it has been removed from the cradle. The Handset LCD design includes a Battery Level meter icon.

Battery Level (Low Charge) – When the Handset reaches a Low battery level during a Talk state, the “Battery Low” tone is played once per minute through the speaker and the Battery Low icon begins to flash indicating approximately 8 minutes of Talk time are remaining. If the Handset is not currently on a call, the battery icon will be flashing. When you press any key, the Handset will emit an error tone and all keypad functions will be disabled (in the event that the battery is too low to initiate a telephone

call). The battery low icon will continue to flash until the battery is recharged or completely discharged.

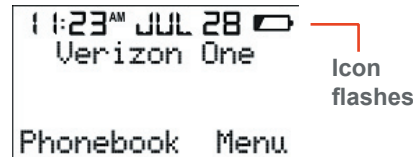

Low battery level indication
(battery icon flashes)

Battery Level (Medium Charge)—When the Handset reaches a Medium battery level, the battery icon is displayed and is “steady,” i.e. not flashing. It will remain on until either a Low charge is reached, in which case the icon will be flashing, or until a High charge is reached by recharging the battery.

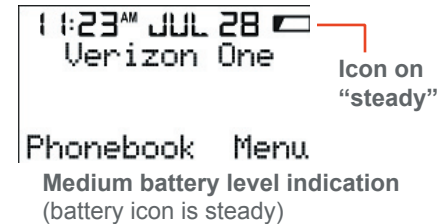

Battery Level (High Charge) – When the Handset is at a High battery level, the battery icon is not displayed.



High battery level indication
(battery icon is not displayed)



Verizon One User Guide

8. Handset Battery

8.3 Battery Charge Indication *(cont'd)*

Battery Level (Full Charge) – If the Handset is fully charged when removed from the Base and in an idle state, the screen will display the “Charging complete” message for 3 seconds or until you press any key. It will then revert to the normal Standby screen.

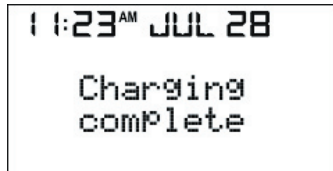



Verizon One User Guide

8. Handset Battery

8.4 Turning On the Handset

Once the battery has been installed and the Handset has been charged, the Handset will be functional. Pressing any key will illuminate the display. The Handset must be registered to the Base Unit before it is operational.

8.5 Using the Handset Belt Clip

If you want to use the belt clip provided with the Handset, snap the belt clip onto the back of the Handset, and then fasten the belt clip and Handset onto your belt. This is an easy and secure way to transport the phone, and is convenient when using the headset jack for hands-free operation.





Verizon One User Guide

9. Registering the Handset to the Base Unit

9.1 Registration Procedure

After successfully charging your **Verizon One** Handset, you must perform a registration procedure to allow the Handset to communicate with the Base Unit. To register the Handset to the Base Unit, perform these steps:

1. Select the <Menu> function on the Handset.
2. Using the round navigation button, scroll down to find the [Registration] menu. Next, press the top left corner key to select Registration.
3. Once you have selected Registration, the Handset will instruct you to press and hold the <Intercom> key on the Base Unit. Press and hold this key for 3 seconds.
4. After 3 seconds, the Handset will automatically register to the Base Unit.

To verify successful registration, press the <Talk/Flash> button on the Handset. A dial tone will be heard from the Handset and a call may be placed successfully. If no dial tone is heard, but the Handset indicated that it had successfully registered with the Base, verify that the Base Unit is connected to an active telephone line and that this line is plugged into the DSL/Phone port on the back of the Base Unit.

Each Verizon One phone comes with one (1) cordless handset. Up to four additional handsets may be purchased separately and registered to the Verizon One base station to create a phone system with five (5) distinct handset and intercom locations.







11:23 AM JUL 28 Verizon One Phonebook Menu	11:23 AM JUL 28 Press and hold Intercom key on Base Exit
11:23 AM JUL 28 Handset Name Date and Time ▶Registration Select ▾ Exit	11:23 AM JUL 28 Verizon One Registered Exit



9. Registering the Handset to the Base Unit

9.1 Registration Procedure *(cont'd)*

You may choose to re-name your Handset. See Section 13.4 for Handset Name Menu instructions.

Note: To select soft key functions displayed on the left side of the LCD screen, press the  key in the top left corner key of the Handset. To select soft key functions displayed on the right side of the screen, press the  key in the top right corner. These buttons are used to select soft key functions only. For example, if you want to select Phonebook, press . To select Menu, press . To scroll up or down, use the round navigation button .



Verizon One User Guide

10. Verizon One Handset Controls

10.1 Handset Control Buttons

The following control buttons are provided on the **Verizon One** Handset:

Note: “Off-Hook” refers to the condition when either the Base Unit or Handset is active in requesting a dial tone or is engaged in a call. “On-Hook” refers to the condition when either the Base Unit or Handset is not active in requesting a dial tone or placing a call.

Button	Function
Volume Up/ Volume Down <i>(On side of Handset)</i>	Pressing these buttons will raise/lower the volume of the Handset Ringer when the Handset is On-Hook. The ringer volume can be set to low, medium, high, or off. The ringer level will be displayed while you are changing the volume. Pressing these buttons when in an Off-Hook mode will adjust the speaker volume.
Talk/Flash	When pressed initially, this button places the phone in an Off-Hook status, and you may dial the desired phone number. When pressed during an active call, it will simulate a momentary press and release of the phone’s hook switch and will put the active call on hold and accept an incoming call as with Call Waiting* or 3-Way Calling** features.
Off/Clear	Pressing <Off/Clear> enables you to end any call by placing the phone On-Hook. <Off/Clear> is also used to clear entries and selections made on the soft-menu available on the Handset LCD.

*Call Waiting subscription is required.

**3-Way Calling subscription is required.



Verizon One User Guide

10. Verizon One Handset Controls

10.1 Handset Control Buttons *(cont'd)*



Button	Function
Hold	When pressed once, this button will place the call on Hold. Press <Hold> again to release the call from hold status.
Intercom	When <Intercom> is pressed on the Handset, it becomes a paging device to locate the Base Unit and/or to establish an intercom call between the Handset and Base Unit. When <Intercom> is pressed, the Base Unit will receive the signal from the Handset, and will ring until the Base Unit is set to an Off-Hook status or until <Intercom> is pressed on the Handset again, thus turning the intercom function off.
Redial	Redial enables you to select one of the last 5 phone numbers entered in the phone. (Note: It will not redial numbers such as passcodes or account numbers that may have been entered after the outgoing call was established.)
12-key Keypad (0-9, *, #)	The Keypad enables you to enter the desired numbers and characters.
Check icons 	Pressing this button will allow you to: <ul style="list-style-type: none"> -Select a menu option from the Main Menu screen -Edit/Erase/Save the option setting



Verizon One User Guide

10. Verizon One Handset Controls

10.1 Handset Control Buttons *(cont'd)*

Button	Function
	Pressing this button will allow you to: <ul style="list-style-type: none">-Access the Handset's Main Menu screen-Delete/Backspace characters-View the settings of an option once it is selected
	Pressing this button enables you to: <ul style="list-style-type: none">-Scroll up/down to the desired menu option-Toggle between sub-level menu options and settings-Select calls displayed on the Handset's LCD screen-Access speed dial numbers



Verizon One User Guide

10. Verizon One Handset Controls

10.2 Handset Activity LED

The Handset includes an Activity LED, also referred to as the “Voice Message Waiting LED,” which performs the following functions:

- **Incoming Ring:** The Activity LED is flashing at a cadence in accordance to an incoming ring pattern. When the ring cadence is ON, the LED blinks.
- **Talk Mode:** If the Handset is in the Talk mode, Intercom, or Voice Mail mode, the Activity LED will be solid blue.
- **Paging:** When the Handset is being paged, the Activity LED will flash according to Paging tone cadence.
- **Call on HOLD or on MUTE:** The Activity LED will blink at 1 Hz rate when you have placed a call on MUTE or on Hold from the Handset.

- **Message Waiting:** When there is a Voice Mail Message waiting and none of the above conditions are present, the Activity LED flashes.

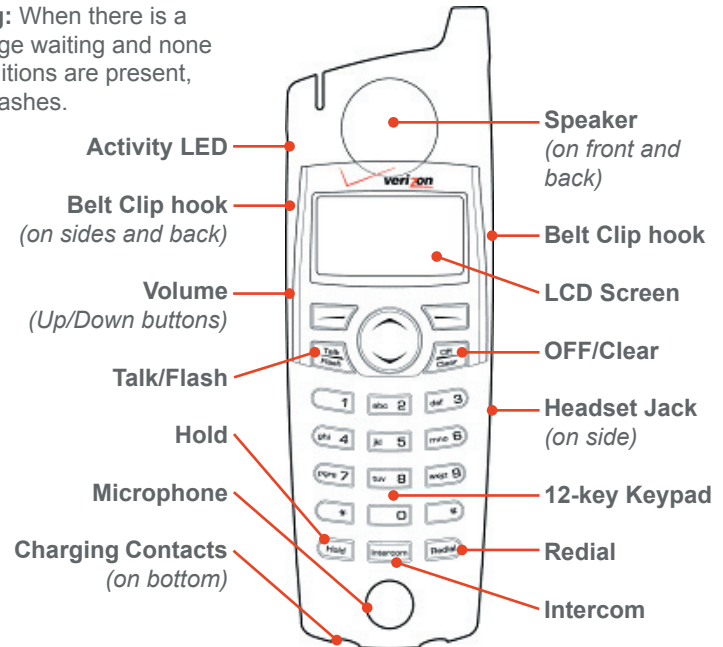



10. Verizon One Handset Controls

10.3 Backlighting

Backlighting refers to the condition when the LCD screen or the buttons on the Handset or the Base light indicate any of the following conditions:

- Incoming Calls
- Pressing Keys
- Paging and/or Intercom functions



Verizon One User Guide

11. Verizon One Handset Screens

11.1 Standby

After you have charged and registered the Handset to the Base, the Standby screen will be displayed on the Handset's LCD screen. The Standby screen provides information such as:

- Current Time and Date
- Battery Level Meter
Note: At a high or full charge, the battery level meter will not be displayed
- Handset Name ("Verizon One" is the Handset's default name)
- Number of New Calls and Messages
- Message Waiting Indicator
Note: The activity LED on the Handset will also blink
- Line Status
- Ringer Muted Indication

While the Standby screen is displayed, you can press <Up/Down> to scroll through the list of Incoming calls. The following examples illustrate the Handset's response to various call conditions:

11.2 No New Calls

When there are no new calls, no messages waiting, and the line is not in use, the Handset will display the following Standby screen:

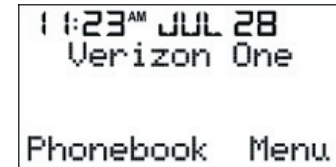



Verizon One User Guide

11. Verizon One Handset Screens

11.3 New Calls

When there are new calls in the Incoming Call Log, no messages waiting, and the line is not in use, the Handset will display the following screen:

```
11:23AM JUL 28
Verizon One
12 new calls
Phonebook Menu
```

11.4 Ringer Off

When the ringer is off, the Handset will display the Ringer OFF icon on the LCD screen:

```
11:23AM JUL 28
Verizon One
12 new calls
Phonebook Menu
```



11.5 New Calls, No Messages Waiting, Line in Use

When there are new calls in the Call Log, no messages waiting, and the line is in use, the Handset will display the following screen:

```
11:23AM JUL 28
Verizon One
15 new calls
Line in use
Phonebook Menu
```



Verizon One User Guide

11. Verizon One Handset Screens

11.6 New Calls, Messages Waiting, Line in Use

When there are new calls in the Incoming Call Log, there are messages waiting, and the line is in use, the Handset will display the following screens, alternately:

```
11:23AM JUL 28  
Verizon One  
Message waiting  
Line in use  
Phonebook Menu
```

```
11:23AM JUL 28  
Verizon One  
15 new calls  
Line in use  
Phonebook Menu
```



Verizon One User Guide

12. Dialing Functions

12.1 Off-Hook Dialing and Dialing Screen

Press <TALK> while the Standby screen appears to go to the Off-Hook state. You will hear a dial tone. Pressed numbers will be dialed out immediately. The following "Talk" screen will be displayed for 5 seconds:

```

11:23AM JUL 28

                Talk
Mute          #
  
```

After 5 seconds, the following Talk screen will display the caller's name, the phone number, the Talk time in minutes and seconds, and the Volume level.

```

11:23AM JUL 28
                John Smith
                (954)123-7654
000:09 Vol-2
Mute          #
  
```

A talk time reading such as "000:09", as indicated above, represents the talk time in minutes and seconds. The timer should then start counting from "000:06" onwards. After counting to "999:59" the timer will change back to "000:00" and continue counting. "VOL-2" indicates the "level 2" talk volume level.

Selecting [Mute] will Mute the Handset microphone. This will alternate the Talk screen with the Call muted screen at 1-second intervals. You may select one of the following options:

```

11:23AM JUL 28
                Call muted

000:09 Vol-2
Unmute       #
  
```

- To unmute the Handset, press <TALK> or select [Unmute].
- Press <Hold> to put the call on Hold.



Verizon One User Guide

12. Dialing Functions

12.2 Preview or On-Hook Dialing

Press number keys (0-9) during the time that the Standby screen appears to go to the Preview Dialing screen, shown below. The number input will first appear on the right side of the 2nd row and will move to the right as a new number is entered. The maximum number of digits accepted for Preview dialing is 32.

The quotation marks "■" indicate that the blinking cursor is ready for input. You may select one of the following options once you have input the number:

- Press <TALK> after you have correctly entered the number. You will hear a dial tone, the number will be dialed and the following Talk screen will be displayed:



- Select [Clear] to delete the last input number(s).

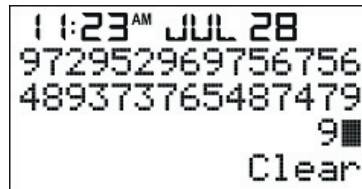

- Select [Save] to initiate a Phonebook entry. Follow the Phonebook "Add a New Name" process.

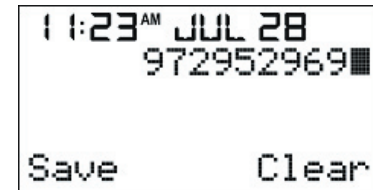



Verizon One User Guide

12. Dialing Functions

12.3 Off-Hook & On-Hook Dialing Alternatives

Both Off-Hook and On-Hook Dialing functions can be accessed using your Incoming Call Log (See Section 12.2), your Phonebook (See Section 14.5), and from the Base Unit (See Section 18.2).

12.4 Placing a Handset Call On Hold

While on a call, press <Hold> to place the call On Hold. Your Handset screen will display the following:

11:23^{AM} JUL 28
Call on hold

000:09 Vol-2
Mute ⚡

A rectangular LCD screen showing the time and date at the top, followed by the text "Call on hold". Below that is a timer "000:09" and "Vol-2", and at the bottom, the word "Mute" followed by a lightning bolt icon.

While On Hold, the Handset will automatically switch to Standby mode and display "Line In Use" on the LCD screen. The following will then be displayed:

11:23^{AM} JUL 28
Verizon One
15 new calls
Line in use
Phonebook Menu

A rectangular LCD screen showing the time and date at the top, followed by "Verizon One", "15 new calls", "Line in use", and "Phonebook Menu" on separate lines.



Verizon One User Guide

12. Dialing Functions

12.5 Redial

Press <Redial> while on the Standby screen to go to the Redial list. The screen will display the last 5 numbers dialed from the Handset or Base Unit. The pointer will start with the most recent number. Press <Up/Down> to scroll through the list. Each redial number shall consist of a maximum of 32 digits. If the outgoing number matches the number of an entry in your Phonebook, the name from your Phonebook will be displayed instead of the number. You may select one of the following options once the arrow is at the desired number:

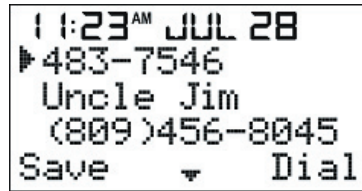

1. Select the number you wish to dial using <Up/Down> to scroll.
2. Press <Redial> again, [Dial] or <TALK> to automatically go Off-Hook and dial the desired number.
3. Select [Save] to save the Number to your Phonebook. Follow the Phonebook entry "Add A New Number" process. After the number is successfully stored, the display will return to the Redial screen.
4. Press <OFF> to return to the Standby screen.

12.6 Incoming Call Screen

When an incoming call occurs, your Handset and Base Unit will ring and the Activity LED will flash during the first ring of the call. If there is an incoming call while the Handset is in a Menu, the Menu will quit and show the Incoming Call screen:

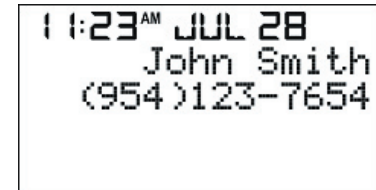

The screen will display the available Caller ID information, including name and number.



Verizon One User Guide

12. Dialing Functions

12.6 Incoming Call Screen (cont'd)

If no name is present through Caller ID, the Handset will then attempt to match the number with your Phonebook. If there is a matching record found, the name field on the screen will display the name as previously input in your Phonebook.

An unanswered call's Caller ID information will remain on the screen for 60 seconds. If another function is performed before 60 seconds, such as pressing <OFF/clear>, <TALK/flash> or the <Up/Down> arrow, the Caller ID information will disappear. If a new call comes in during this time, the Caller ID information will be updated.

12.7 Call Waiting Screen

If you have subscribed to a Call Waiting service, a Call Waiting tone will be generated every 6 seconds. A Call Waiting service will allow you to receive a second call while currently engaged on a call. The Talk screen will alternate in 1-second intervals with the Call Waiting Caller ID information, if available. You can press <Talk> to flash the line and toggle between callers.

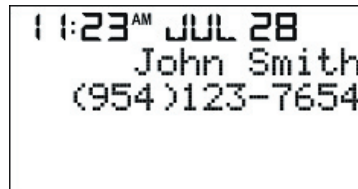





Call Waiting
Caller ID Name
and Number



Verizon One User Guide

13. Using the Verizon One Handset Menu

Note: To select soft key functions displayed on the left side of the LCD screen, press the  key in the top left corner key of the Handset. To select soft key functions displayed on the right side of the screen, press the  key in the top right corner. These buttons are used to select soft key functions only. For example, if you want to select Phonebook, press . To select Menu, press . To scroll up or down, use the round navigational button .

To access the Handset's Menu:

1. Select [Menu] in the Standby screen.



2. The following Menu screen will be displayed: The pointer [▶] will be pointing to the [Incoming Calls] menu.

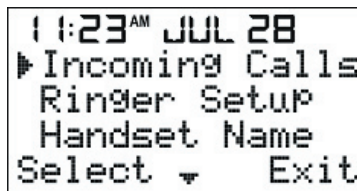

3. Press <Up/Down> to scroll through the Menu options. Stop the pointer at the desired Menu option.
4. Select [Select] to confirm your choice. If you select [Exit], you will return to the Standby screen.

After you have selected a Menu option, the Sub-Menu will be displayed. Select the desired Sub-Menu option, and select [Select] to confirm your choice.



13. Using the Verizon One Handset Menu

The following chart displays Main Menu and Sub-Menu options available to the Handset:

Menu Option	Sub-Menu Option(s)
Incoming Calls Log	View list of incoming calls, displaying Caller ID information, if available. Up to 40 records are in the log. From this log, you will be able to do the following: Save – Save incoming call. Erase – Erase saved call. Erase All – Erase all saved calls.
Ringer Set-up	Ringer Volume – Set the volume to the desired level on your Handset (Off, Low, Medium, High). Ringer Tone – Select the melody that you want to use for the Ringer. Keypad Tones – Turn On/Off keypad confirmation tones.
Handset Name	Enter a name of your choice to customize your Handset. “ Verizon One ” is the default Handset name.
Date and Time	Enter the desired Date and Time settings.
Registration	View the Handset’s registration information. Registration of the Handset to the Base Unit must occur before using the Handset. Instructions are detailed in Section 9.



Verizon One User Guide

13. Using the Verizon One Handset Menu

13.1 Incoming Calls Log

When the [Incoming Calls] menu is selected from the Menu screen, the most recent incoming calls will be displayed with the Caller ID information available and the time and date received. You can scroll through the list using <Up/Down> to see your incoming calls in the order received starting with the most recent. The time and date of the call is displayed at the top of the screen (instead of the current time and date).

The Incoming Call Log will hold up to 40 records. Once full, the oldest records are dropped for the newest records.

If [Incoming Calls] is selected and there are no Incoming Call Logs available, the Handset will emit an error tone, and the following “No calls” screen will be displayed along with the current time and date:

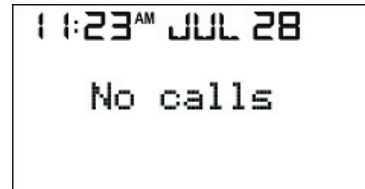

In addition to viewing your Incoming Call Log, you may use this list to do the following:

13.1.1 Place a Call

To dial a phone number from the Incoming Calls Log, scroll to the desired record and press <Talk>. The phone will automatically go Off-Hook and dial the selected number.

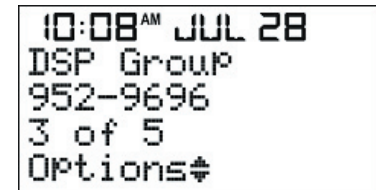



Verizon One User Guide

13. Using the Verizon One Handset Menu

13.1.2 Save a Record to your Phonebook

To save a call record from the Incoming Calls Log to the Phonebook, scroll to the record that you want to save. Select [Options] to display the following “Save/Erase/Erase All” screen. Select [Save]:

```

10:08 AM JUL 28
▶ Save
  Erase
  Erase All
Select ▼ Exit
  
```

If your Phonebook is not full, additional entries can be added, and the “Name” screen will be displayed. Follow the instructions in the Phonebook Section 13. Your Phonebook will store up to 50 entries.

Once your Phonebook is full, you will receive an error tone and a “Phonebook full” message. After 2 seconds, the screen will return to the next Incoming Call record.

13.1.3 Erase Call from the Incoming Calls Log

To erase a call from the Incoming Calls Log, scroll to the desired record and select [Options] to display the following “Save/Erase/Erase All” screen:

```

10:08 AM JUL 28
▶ Save
  Erase
  Erase All
Select ▼ Exit
  
```

Select [Erase]. The Handset will display the “Entry erased” screen. After 2 seconds, the screen will return to the next Incoming Call record. If there is only one record, and you choose to erase this record, the screen will return to Standby.



13. Using the Verizon One Handset Menu

13.1.3 Erase Call from the Incoming Calls Log *(cont'd)*

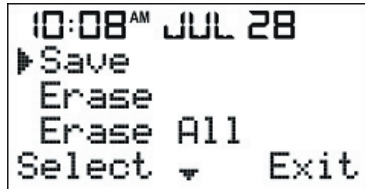

Selecting [Erase All] enables you to erase all records from the Incoming Calls Log. The screen will display the [Erase all?] screen above, prompting you to confirm your selection. Select [OK] to erase all entries in the Incoming Calls Log. Select [Exit] to cancel the “Erase all” action.

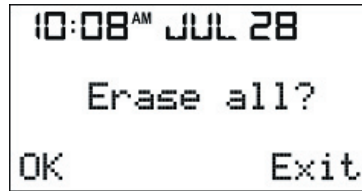

If you select [OK] in the “Erase all?” screen, the following “List erased” screen will be displayed. After 2-seconds, the screen will return to Standby:

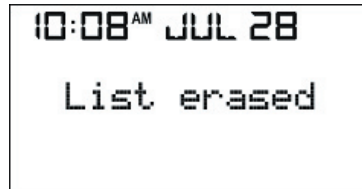

13.2 Ringer Setup Menu

Select [Ringer Setup] from the Menu screen, for the following options:

- Ringer Volume
- Ringer Tone (Melody)
- Keypad Tones



Verizon One User Guide

13. Using the Verizon One Handset Menu

13.2.1 Ringer Volume

When you select [Ringer Volume] the screen below will be displayed with the current volume. "Medium" is the default ringer volume. Select [Change] and scroll <Up/Down> to change Ringer Volume to either "Medium," "High," "Low," or "Off". (**Note:** The difference between the levels is 6 dB.) Select [Save] to confirm your settings. You will then be returned to the Menu screen:



13.2.2 Ringer Tone (Melody)

When you select [Ringer Tone] the screen on the right will be displayed with the current tone. "Standard" is the default ringer tone. Select [Change] and scroll <Up/Down> to switch to a different Melody. As you scroll through you will hear each melody option. Ten melodies are available for selection.

Once the desired melody is identified, select [Save] to confirm. You will be returned to the Menu screen Press <OFF> to return to the Standby screen without saving changes and to stop playing the test Melody.

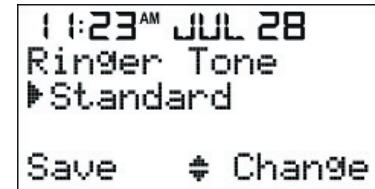



Verizon One User Guide

13. Using the Verizon One Handset Menu

13.2.3 Keypad Tones

When you select [Keypad Tones] the following screen will be displayed with the arrow at the current status. “On” is the default Keypad Tones setting. Select [Change] if you want to change the Keypad Tones to “Off.” Select [Save] to save your settings. You will then be returned to the Menu screen:

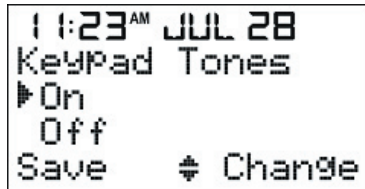

13.3 Handset Name Menu

This feature allows you to assign a name to your registered Handset. When the [Handset Name] menu is selected, the screen will display the current Handset name:

Note: “Verizon One” is the default Handset name.

1. Enter a name at the blinking underscore using the keys (0-9, *, #) on the Handset keypad. After you enter a character, the underscore will advance to next space on the right (**Note:** The maximum number of characters that can be used for a name is 12).
2. Select [Clear] to clear the digit/letter on the left of the blinking underscore.

3. Press <OFF> to return to Standby without saving the new name.
4. Select [Save] to save the Handset name and to return to the Menu screen (regardless of whether the Handset name has or has not been modified):

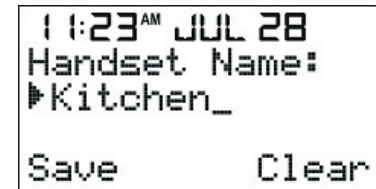



13. Using the Verizon One Handset Menu

13.4 Date and Time Menu

When the [Date and Time] menu is selected, the pointer will be positioned at the Time setting, and the first digit of Time will blink, waiting for your input:

1. Enter the first digit. Once entered, the second digit will blink. Continue to enter the correct Time. The blinking occurs in the following sequence: 1st -> 2nd (skip the colon :) -> 3rd -> 4th -> in endless loop until <Up/Down> is pressed. An error tone will be given if an invalid digit is entered.
2. Select [AM/PM] to change the current "AM" setting to "PM" and vice versa.
3. Press <Up/Down> to display the Date screen, or
4. Press <OFF> to return to Standby or select [Save] to save the settings and to return to the Menu screen:

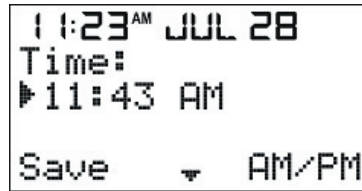

When the [Date and Time] menu is selected, the pointer will be positioned at the Time setting, and the first digit of Time will blink, waiting for your input:

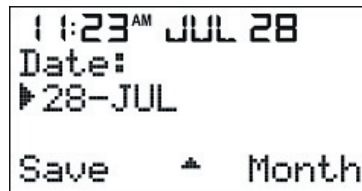

1. Enter the correct Date following the cursor as done with the Time setting.
2. Select [Month] to change the current Month setting.
3. Select [Save] to save the settings and to return to the Menu screen.

Error checking of valid dates takes place on [Save]. If the Date is not valid, an error tone is played and you will be returned to the Date editing screen which will display the last valid Calendar Date for the specified month. The first digit will then blink while waiting for input. (For example, 31-JUN is substituted with 30-JUN).

4. Press <OFF> to return to the Standby screen without saving changes.
5. If <Up/Down> is pressed at this time, the display will return to the Time screen.



Verizon One User Guide

14. Using the Handset Phonebook Menu

14.1 View Your Phonebook

The Phonebook within your Handset is available to store Names and Numbers for easy access and dialing:

Phonebook and Phone Number Features	Quality
The maximum number of entries that the Phonebook can contain	50
The maximum number of characters for name entry	11
The maximum number of digits for phone number entry	24

To access your Phonebook, select [Phonebook] from the Menu. The following screen will be displayed, and the pointer will be positioned at "(Add New Name):"

```

11:23AM JUL 28
▶ (Add New Name)
 1 John Smith
 2 Vicky Jones
Select ▼
  
```

Press <Up/Down> to scroll through the list of Phonebook entries, or press a number (1 - 50) to go directly to an entry, and then select [Select]. **Note:** The second digit is ignored if the number entered is greater than the number of entries in the Phonebook.

When the pointer is at a Name in the Phonebook list, the following screen will be displayed:

```

11:23AM JUL 28
 (Add New Name)
▶1 John Smith
 2 Vicky Jones
Options▼ View
  
```



Verizon One User Guide

14. Using the Handset Phonebook Menu

14.1 View Your Phonebook (cont'd)

Select [View] when the pointer is at the desired entry, to view the telephone Number for that entry.

After selecting a phone entry, press <TALK> to go Off-Hook and dial the selected phone number:

```

11:23AM JUL 28
1 John Smith
   357-8578

Options      Exit
  
```

When a Name exists, a Phonebook entry is displayed by Name. When a Phonebook entry has no associated Name, the entry will be displayed by the phone Number.

If the Number has more than 11 digits and less than 23, the display is swapped with two pages. Each page will then be displayed at an interval of 3 seconds. If the number has more than 22 digits, the display is then swapped with three pages which each display at an interval of 3 seconds.

If there are no entries in your Phonebook, the "Empty List" message will be displayed on the screen:

```

11:23AM JUL 28

Empty list
  
```

14.2 Add a New Name

To add a new name, select [Select] when the pointer is at (Add New Name). The Name screen below will be displayed. This screen will prompt you for Name information:

Note: If the Phonebook is full, you will not be able to enter a new name until excess entries are erased from the Phonebook. The Phonebook holds up to 50 names.

```

11:23AM JUL 28
Name:
▶ _
Save      ◀ Clear
  
```



Verizon One User Guide

14. Using the Handset Phonebook Menu

14.2 Add a New Name (cont'd)

1. Enter a name with up to 11 characters at the blinking underscore using the keypad characters (0-9, *, #).

Note: If you try to input more than 11 characters, an error tone will be heard and additional input will not be accepted.

If you are saving a Name from your Incoming Calls Log, the caller's Name will be already be displayed in the "Name" field as it appeared on your Caller ID, as displayed below:

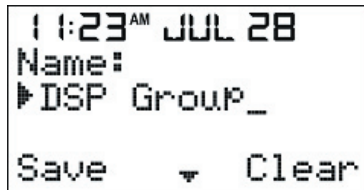

2. Select [Clear] to delete (backspace) characters.
3. Press <OFF> to return to the Standby screen. This will cancel your input. Or,
4. Press <Up/Down> while you are at the Name screen to display the Number screen:

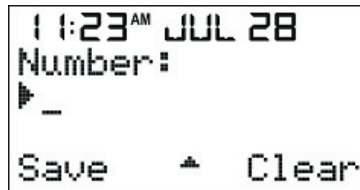

5. Enter a number at the blinking underscore using the keypad characters (0-9, *, #). Ignore dashes as they will be inserted for you.

If you are saving a Number from your Incoming Calls Log, the caller's Number will be displayed in the "Name" field as it appeared on your Caller ID, as displayed below:

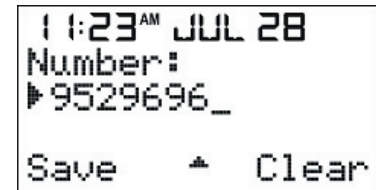

6. Select [Clear] to delete (backspace) numbers, if you make an error.

Note: Press the # symbol once to enter "#." Press the # symbol twice to insert "P," which provides a 3 second pause during dialing. If you try to input more than 24 digits, an error tone will be heard and additional digit input will not be accepted.



14. Using the Handset Phonebook Menu

14.2 Add a New Name (cont'd)

The phone number will be formatted according to the following rules:

	String of Digits	Screen Format
1	7 digit number	### #####
2	8 digits, leading digit 1	1 ### #####
3	10 digits	(###)### #####
4	11 digits, leading digit 1	1(###)### #####
5	Other cases	No formatting

- Press <OFF> to return to the Standby screen. This will cancel your input. Or,
- Press <Up/Down> to go back to the "Name" input screen. Or,
- Select [Save] to store the entry to your Phonebook. The entry will automatically be listed in alphabetical order, and the list will be re-numbered.

After you [Save], the following "Name saved" screen will be displayed for 2 seconds, and then will return to the Phonebook List:

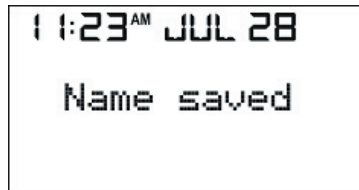

If you selected [Save] but did not enter a Name, the empty Name record is treated as "space" and is sorted to the beginning of the list regardless of the Number field, using first found/first display. The screen then returns to "Add New Name" in the Phonebook.

If you selected [Save] but did not enter a phone Number, a "No Number Entered" message will be displayed on the screen for 2 seconds. An error tone will then be heard, and the screen will return to the "Number edit" screen so that you can add the Number.



Verizon One User Guide

14. Using the Handset Phonebook Menu

14.2 Add a New Name (cont'd)

The following screen will be displayed:

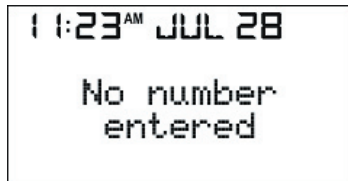

If the Phonebook is full when you select (Add New Name), a “Phonebook full” message will be displayed for 2-seconds. When the Phonebook is full, you can store a new Name entry only after an existing entry has been erased:



14.3 Edit a Phonebook Entry

To edit a Phonebook entry, select [Options] when the pointer is at the desired entry. The following screen will be displayed with the pointer at [Edit]:

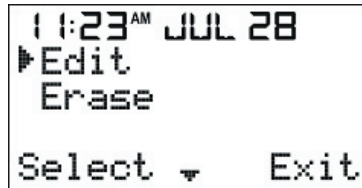

1. Select [Edit]. The following “Name” screen will be displayed:

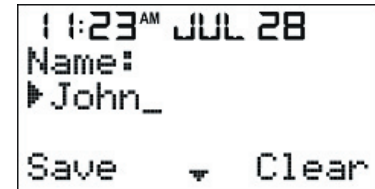

2. The Name will appear with the blinking underscore.
3. Select [Clear] to delete (backspace) characters that you wish to edit.
4. Using the keypad characters (0-9, *, #), enter the edited Name. (**Note:** If you input more than 11 characters, an error tone will be heard and additional characters will not be accepted).



Verizon One User Guide

14. Using the Handset Phonebook Menu

14.3 Edit a Phonebook Entry (cont'd)

5. Select [Save] to save your settings and to return to Standby.
6. Press <OFF> to return to the Standby screen.
7. Continue by editing the Number, press <Up/Down>. The display will show the corresponding Number of the Name you have selected, as follows:

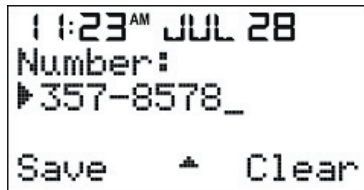

8. Select [Clear] to delete (backspace) numbers that you wish to edit.

9. Enter a number at the blinking underscore using the keypad characters (0-9, *, #).

Press the # key once to insert a “#.” Press the # key twice to insert “P,” which will insert a 3 second pause during dialing. **Note:** If you try to input more than 24 digits, an error tone will be emitted, and the digit input will not be accepted.

10. Select [Save] to store the entry to the Phonebook which will list entries in alphabetical order and re-number the list. The “Name saved” screen will be displayed for 2-seconds, as shown above. The display then will return to the [Edit] option in the Phonebook List:

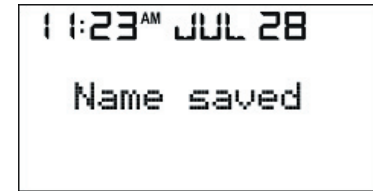

11. Press <OFF> to return to the Standby screen. Or,
12. Press <Up/Down> to go back to the “Name” input screen.



Verizon One User Guide

14. Using the Handset Phonebook Menu

14.4 Erase a Phonebook Entry

To erase a Name and Number from the Phonebook, choose the desired Name or Number and select [Erase]. The Name and Number will be erased, and the Phonebook will be re-numbered. The Handset will display the "Entry erased" message for 2 seconds, and then the screen will return to the Phonebook List, as follows:

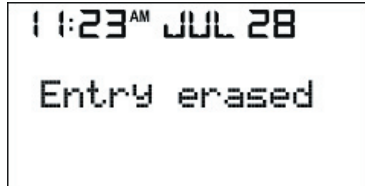

11:23^{AM} JUL 28
Entry erased

14.5 Place a Call

While On-Hook, scroll to the desired Name and Number, or press a number (1 - 50) to go directly to the entry, in your Phonebook, and press <Talk>. The phone will automatically go Off-Hook and dial the selected number.

While in the Off-Hook/Talk mode, scroll to the desired Name and Number in your Phonebook. The Handset will display the following screen:

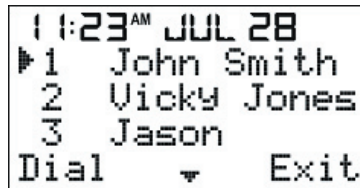

11:23^{AM} JUL 28
▶ 1 John Smith
2 Vicky Jones
3 Jason
Dial ▾ Exit

Select [Dial] to dial the number in the pointed entry, or select [Exit] to return to the Talk screen.



Verizon One User Guide

15. Using Intercom and Call Transfer Functions

15.1 Intercom Functions

The Handset for the **Verizon One** Base Unit has the default name “**Verizon One**” and the Base is called “Base.” These names assist in understanding the Intercom and Call Transfer Functions discussed in this section.

15.1.1 Paging the Base

To page the Base from the Handset, press <Intercom> on the Handset. The Base is automatically paged. The Handset will display the following screen:



When the Base goes Off-Hook, the Base and the Handset are able to talk to each other.

Select [Exit] on the screen, or press <OFF> or <Intercom> to stop paging or to release the call. You will be returned to a Standby mode.

The Base will see “**Verizon One** paging” on its screen. When the Base goes Off-Hook, the Base and the Handset are able to talk to each other.



Verizon One User Guide

15. Using Intercom and Call Transfer Functions

15.1.2 No Answer From a Page

If a Page is not answered, a “No answer” message will be displayed on the device that originated the Page when:

- There is no answer from the Paged party after two minutes
- The Paged party chose not to answer by pressing [Exit] or <OFF> “**Verizon One.**” The Handset can respond to a “No answer” message in one of the following ways:
 - Select [Exit] and the Handset returns to a Standby screen
 - Press <OFF>
 - Wait for the Page to timeout and return to the Standby screen

15.1.3 Using the Intercom During an Active Call

When you are on an active call, press <Intercom> on the Handset which will put the call On Hold and start the paging menu. The Base will automatically be paged. You will see “Call on Hold” BLINKING on the Handset screen.

Select [Exit] or press <Intercom> if you want to stop paging, take a call off hold, or return to the TALK mode:

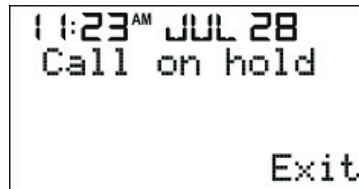

If <Speakerphone> or <Intercom> is pressed on the Base, an intercom connection is established with “**Verizon**

One,” and “Base”. The external call is still on Hold. The Talk screen will alternate with the “Intercom Base Vol-2” and the “Call on Hold” screen in 1-second intervals.

If the Base disconnects the Intercom page the “**Verizon One**” Handset will return to a TALK mode and display the “Call on Hold” message. You can then press [Unhold] to return to the external call:

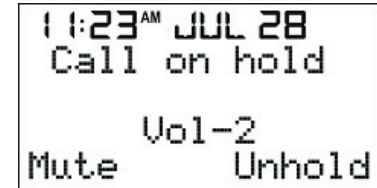

This same process is used to Transfer a Call or to Conference the external caller with the Handset and the Base, as described in the next sections:



Verizon One User Guide

15. Using Intercom and Call Transfer Functions

15.2 Call Transfer Functions

15.2.1 Completing a Call Transfer

An external call received on the “**Verizon One**” Handset may be transferred to the Base by pressing <Hold> on “**Verizon One**” and then pressing <Intercom> to automatically page the Base. “**Verizon One**” will display “Call on Hold” and “Paging Base,” switching messages alternatively.

If “**Verizon One**” presses <OFF> on the Handset at this moment, the Handset will display a “Line In-Use” message. The Base will ring and display a “Transfer from **Verizon One**” message, as shown in the screen above. Press the <Speakerphone> button on the Base to accept the call transfer. The Base is now connected with the external caller:

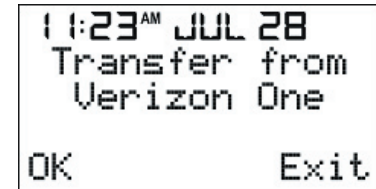



Verizon One User Guide

15. Using Intercom and Call Transfer Functions

15.2.2 Call Back

If the “**Verizon One**” user presses <OFF> to transfer a call and the Base does not answer, after 30 seconds of ringing, the Base will stop ringing and the ringing will “return” to “**Verizon One**.” The Base will acknowledge the “Line In Use” screen and the call will be “called back” to “**Verizon One**.” “**Verizon One**” will ring and display a “Call back” message to let the Handset user know that this is the external call coming back.

To accept the call back, the “**Verizon One**” user presses the <TALK> button to be reconnected.

If the “**Verizon One**” user selects [Exit] or presses <OFF> during the Call back, “**Verizon One**” will stop ringing, drop the external call, and return to the Standby screen. The external call is now disconnected. If the “**Verizon One**” user does not answer the Call back and does not select [Exit] or press <OFF>, the call will ring until the caller hangs up.

15.3 3-Way Conferencing

With an external call on Hold with “**Verizon One**”, and while “**Verizon One**” is on an intercom call with the Base, a 3-way conference may be started between “**Verizon One**,” the Base and the external caller. To set up 3-way conferencing, “**Verizon One**” presses <Hold> or [Unhold]. After either of these keys is pressed, both “**Verizon One**” and the Base will display the screen below:





Verizon One User Guide

15. Using Intercom and Call Transfer Functions

15.3 3-Way Conferencing (cont'd)

The Handset may select one of the following options:

- Press <OFF> on “**Verizon One**” to quit the conference. The Base can continue the external call alone. Or, similarly, the Base can disconnect to quit the conference and leave “**Verizon One**” to continue the external call alone.
- Press <OFF> on both “**Verizon One**” and the Base to disconnect the external and intercom calls.
- Press <Hold> on either the Handset or the Base to put the external call on Hold and the Base and “**Verizon One**” can continue the intercom call internally.

15.3.1 3-Way Conference

If a person is on the Handset talking to an outside caller while a second person at the Base station would like to join the conversation in a “3-way conference,” the person on the Base can press <Speakerphone> to join the call. A “New Party Joined” tone is emitted to alert the other parties that another person has joined in the call. A “Conference” message will also be displayed on both screens.

15.4 Handset Locator

To locate your Handset, press <Intercom> on the Base which will automatically page the Handset. You will be able to locate the Handset by tracking the Page tone that is emitted (even if the Handset ringer is OFF). During this process, the “Base paging” message will be displayed on the Handset:

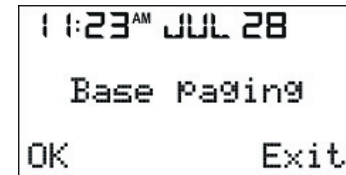

The registered Handset will emit a Paging tone for 2 minutes and then return to the Standby screen. To stop the Paging tone on the Handset, select [Exit] or <OFF> on the Handset or press the <Intercom> button on the Base.



Verizon One User Guide

15. Using Intercom and Call Transfer Functions

15.5 Out-of-Range Detection

If the Handset detects an out-of-range condition, it will start searching for the Base and display the following screen:

11:23^{AM} JUL 28
Connecting...
Phonebook Menu

A screenshot of a mobile phone's standby screen. The time and date are displayed at the top. The main text reads "Connecting..." and at the bottom, there are two menu options: "Phonebook" and "Menu".

After the Handset finds the Base, the Handset will display the Standby screen. If the Handset cannot find the Base, the Handset will emit an error tone and display an "Out of range" message. The user should then move closer to the Base until the Handset is within range again:

11:23^{AM} JUL 28
Out of range
Phonebook Menu

A screenshot of a mobile phone's standby screen. The time and date are displayed at the top. The main text reads "Out of range" and at the bottom, there are two menu options: "Phonebook" and "Menu".



Verizon One User Guide

16. Headset Support

Your **Verizon One** Handset is equipped with a 2.5 mm Headset jack for use with an optional accessory Headset for hands-free operation. If you choose to use the Headset option, you must do the following:

1. Obtain an optional accessory Headset.
2. Locate the Headset jack on the side of the Handset.
3. Connect the plug on the Headset cord to the jack on the Handset. **Note:** The plug should fit securely. Do not force the connection.
4. Once the Headset is connected to the Headset jack, the audio paths to the Handset microphone and earpiece speaker are disconnected. The Volume <Up/Down> buttons control the Headset earpiece speaker volume. Ringer alerting remains active on the Handset speaker.



Verizon One User Guide

17. Verizon One Base Unit Controls

17.1 Base Speakerphone Control Buttons

The following control buttons are provided on the **Verizon One** Base Unit for control of the Base Speakerphone:

Note: “Off-Hook” refers to the condition when either the Base or Handset is active in requesting a dial tone or is engaged in a call. “On-Hook” refers to the condition when either the Base or a Handset is not active in requesting a dial tone or placing a call.

Button	Function
Menu	Pressing this button takes you to the touch-screen Menu.
Address Book	Pressing this button takes you to the Address Book.
Speakerphone ON/OFF Button	Pressing the Speakerphone button will take the telephone Off-Hook, enabling the speaker with an audible dial tone. The button will illuminate and remain lit until it is pressed again to turn off the speakerphone.
Speed Dial	Pressing this button launches the Speed Dial application on the device, and enables you to see all speed dial numbers.
Flash	Pressing this button simulates a momentary press and release of the phone’s hook switch. When pressed initially, this button places the phone in an Off-Hook status. When pressed during an active call, this button puts the active call on hold and accepts the incoming call as with Call Waiting* or 3-Way Calling**.
Redial	Pressing this button enables you to redial the last number that was entered in the phone. (Note: It will not redial numbers such as passcodes or account numbers that may have been entered after the outgoing call was established).

*Call Waiting subscription is required.

**3-Way Calling subscription is required.



Verizon One User Guide

17. Verizon One Base Unit Controls

17.1 Base Speakerphone Control Buttons (cont'd)

Button	Function
Intercom	Pressing this button will automatically begin paging the Verizon One handset.
Volume Up Volume Down	Pressing and holding either of these buttons will continually raise/lower the volume of the audio that emanates through the speaker until the button is released or a maximum/minimum level is reached. When the phone is On-Hook and ringing, the volume control buttons revert to controlling the phone's ringer volume. The ringer volume may be turned down to the point that it is turned off.
Mute	When pressed initially, the Mute button will Mute Verizon One's microphone so that the party on the other end of the telephone call may not hear audio. This button will illuminate and remain lit while Mute is activated. When the Mute button is pressed again (Mute is deactivated) the microphone will become active and the call will become audible to the party on the other end of the telephone call.
Hold	When pressed once, this button will place the entire call on Hold. Press the Hold button again to release the call from a Hold status. The Hold button will illuminate and flash while the call is in a Hold status.
12-key Keypad (0-9, *, #)	Pressing these keys enables you to enter the desired characters.



17. Verizon One Base Unit Controls

17.2 Base Activity LED

The Base Unit includes an Activity LED, also referred to as the “Voice Message Waiting LED,” which performs the following functions:

- **Incoming Call:** The Activity LED is flashing at a cadence in accordance to an incoming ring pattern. When the ring cadence is ON, the LED blinks.
- **Talk Mode:** If the Base is in a Talk mode, Intercom, or Voice Mail mode, the Activity LED lights solid blue.
- **Paging:** When the Base is being paged, the Activity LED will flash according to the Paging tone cadence.
- **Call on HOLD or on MUTE:** The Activity LED should blink at 1 Hz rate when the Base has placed a call on MUTE or on HOLD.
- **Message Waiting:** When there is a Voice Mail message waiting and none of the previous conditions are present, the Activity LED flashes. (This feature requires an optional subscription to Verizon Voice Mail service).



Verizon One User Guide

17. Verizon One Base Unit Controls

17.2 Base Activity LED (cont'd)

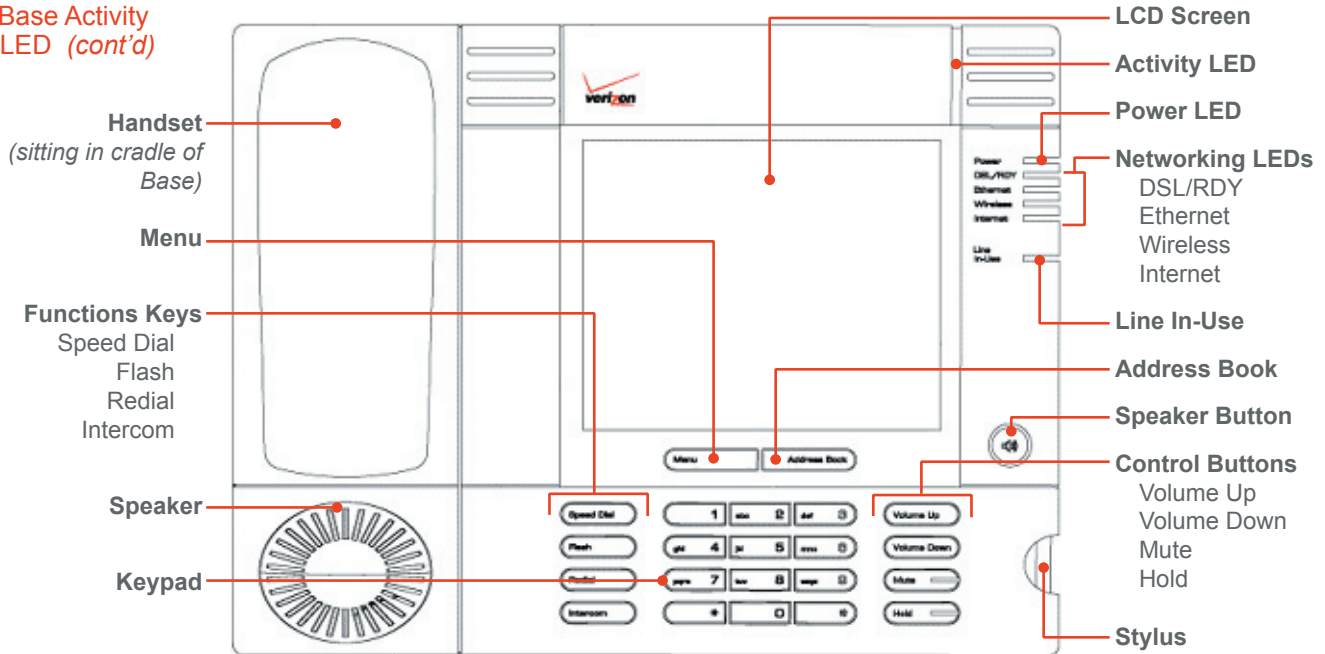



Verizon One User Guide

18. Verizon One Base Unit Operations

18.1 Base, Stylus and Touch-Screen

If you are using **Verizon One** in Active Mode, you will perform most of your interactions through the Base Unit's touch-screen. For details on how to use these additional features and navigate the touch-screen display, see Section 19 Touch-Screen Features.

A stylus is provided with the Base and, by using the stylus, you can gently tap the components in the touch-screen and navigate to various features. The stylus, which is included with your **Verizon One** kit, is stored in the stylus holder located on the right side of the **Verizon One** base. To use the stylus, firmly press the stylus to disengage it from the stylus holder on the Base. Then, use the pointed end of the stylus to gently tap the touch-screen.

Important: Always use the point of the stylus for tapping on the touch-screen and making selections. **Please do not use a pen, pencil or other pointed object on the touch-screen as these items may cause damage to the screen.** If the touch-screen becomes soiled, use a damp, clean cloth moistened with a window-cleaning solution to gently wipe the screen. Please do not use an abrasive as this may scratch the screen.

18.2 Making and Ending Calls

To make a call from the Base Unit, press the speaker button. The phone will go Off-Hook and give a dial tone. You may then dial the desired number. To end a call, press the <Speaker> button. The phone will go On-Hook and disconnect the call.



Verizon One User Guide

18. Verizon One Base Unit Operations

18.3 Answering Incoming Calls

To answer an incoming call, from the Base Unit, press <Speaker> during an incoming call ringtone. After you press <Speaker>, the Base will go Off-Hook and you may begin speaking.

18.4 Transferring Calls from the Base to the Handset

By lifting the Handset from the Base and pressing <Talk> during an active call, the user will be connected to the call.

18.5 Transferring Calls from the Handset to the Base

If you place the Handset into the Base cradle and do NOT press <OFF> on the Handset while the Base is connected to an active call, the Handset will be disconnected from the call, and the call will remain active for the Base and/or any other Handsets.

Note: If the Handset is placed into the cradle after placing a call on HOLD, and the Base is connected to the call, the call will not be disconnected.

If you have an active call from the Handset, but not on the Base, and you want to transfer the call to the Base, press <Speaker> on the Base. The call will transfer from the Handset to the Base.



Verizon One User Guide

18. Verizon One Base Unit Operations

18.6 Paging from the Base

To page the Handset from the Base Unit, press <Intercom> on the Base. The Base will page the Handset for approximately two minutes and then stop paging. If the Handset responds (by pressing <Intercom> within the two minutes of paging), it will end the page and start an intercom call.

18.7 Adjusting the Volume

To adjust the volume on the Base Unit, press <Volume Up> or <Volume Down> on the front of the Base.

18.8 Using the Mute Button

To place an active call into a Mute state, press <Mute> on the Base. The <Mute> button will illuminate when the call is set to Mute. To return the call to normal conversation, press <Mute> again.



18. Verizon One Base Unit Operations

18.9 Using the Hold Button

To place the call in a Hold state, press <Hold> on the Base. The <Hold> button will illuminate (flashing) when the call is on Hold. Press <Hold> again to return to the call.

18.10 Using the Menu and Address Book Buttons

Pressing the <Menu> button takes you to the touch-screen Menu. Pressing the <Address Book> button takes you to your Address Book.



Verizon One User Guide

19. Touch-Screen Features

19.1 Touch-Screen Navigation

Verizon One's visual touch-screen display provides access to everything you use most often. This section shows how to navigate using the touch-screen menu.

One-Touch Screen Features

Home Screen

The **Home** screen allows access by providing shortcuts to the **Menu** and popular menu options such as **Calls & Memos** and **News & More**.

Your **Home** screen picture and weather settings can be customized by selecting **Settings** from the **Menu**.

Touch the **Home** icon  on any screen to return Home.

Select one of the following from the **Home** screen to get:

Calls & Memos

Access to communications tools such as Calls, Memos and Voice Mail*.

News & More

Access to information such as News, Sports, Movies and more.

Menu

Your direct link to your Calls, Address Book, Calendar, Verizon SuperPages, Settings, and every **Verizon One** feature accessible via touch-screen.

Shortcuts

Choose to have quick access to a handful of features.

Volume

Control the volume of your device, or silence it, from the **Home** screen.



Home

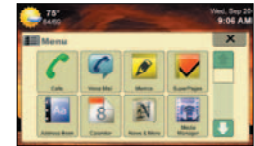

Menu

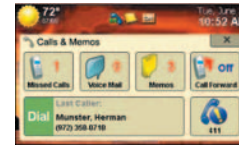

Calls & Memos



Shortcuts

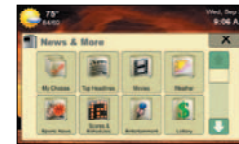

News & More



Volume

*Available to Verizon Home Voice Mail subscribers only



Verizon One User Guide

19. Touch-Screen Features

19.1.1 Menu



Calls: Access your incoming and outgoing call logs***, add callers directly to your Address Book or call back with one touch.



Voice Mail:** One touch to access your Voice Mailbox and listen to your messages.



Memos: Use a keypad or freestyle memo pad (using the stylus) to jot down numbers or leave notes for other household members.



SuperPages*: Search and view residential and business listing information, access maps and directions, and direct dial with one touch.



Address Book*: Access and manage your online address book with the ability to directly place calls from it.



Calendar*: Access and manage your online calendar, schedule appointments, make task lists and more.



News & More*: Check local weather and the 5-day forecast (for your home or any ZIP code), read news and sports headlines, review movie listings, find theaters and show times, get sports scores, watch favorite stocks and read your daily horoscope.



Verizon Messages: Receive messages about your Verizon account and service status.



Emergency Numbers: Create and dial from a list of your saved emergency phone numbers including Police, Fire, Hospital, Doctor and Poison Control.



Verizon One User Guide

19. Touch-Screen Features

19.1.1 Menu (cont'd)



E-Mail:** Check and send E-Mail directly from the **Verizon One** device.



Alarm/Timer: Set an Alarm, use the Timer or start the Stopwatch to keep time.



Calculator: Perform basic calculation functions like addition, subtraction, multiplication and division.



Speed Dial: One touch to dial a phone number from your saved speed dial numbers.



Settings: Select your Display, Backgrounds, Screensavers and Ringtones.



Phone Tips: Reference dialing shortcuts that you can use for some of the most common phone applications—such as dialing the last person who called you (*69).



Wireless*: Share your single DSL connection with multiple computers and hardware devices in your household - create a local wireless network with **Verizon One's** combination DSL modem and wireless router.



Help: Get instructions, find FAQs and locate helpful Web sites.

*Display of these features requires your DSL service to be active. Once your Service Ready Date has arrived, and **Verizon One** detects an active DSL connection—these features will automatically appear.

**Available to Verizon Home Voice Mail subscribers only.

***Caller ID subscription is required.



Verizon One User Guide

19. Touch-Screen Features

19.1.2 Touch-Screen Keyboard and Numeric Keypad

Select  or touch an entry field to access the keyboard - or - in the case of number fields, a numeric keypad. Note that you can select **Shift** for capital letters and the @ sign, etc.

When entering a phone number on the keypad, use ONLY ten digits (area code + phone number). Do NOT enter a 1 before the area code.

19.1.3 Incoming Calls, Outgoing Calls and Voice Mail Logs

From Calls & Memos:

Select **Calls & Memos** from the **Home** screen for a summary of Missed Calls, Memos, and Voice Mail waiting for you. You may select **Dial** to dial the person who last called you (if Caller ID information is available for the Caller).

From Menu:

From **Home**, select **Menu**, and then select **Calls** for your Incoming Calls, Outgoing Calls and Voice Mail Logs. The **Incoming Calls** screen appears. Select the **In**, **Out** or **Voice Mail** tab:

In tab: When the **In** tab is selected, you have a view of all **Incoming Calls** and related data. View your most recent 50 Incoming Calls. Each entry in the Log represents a Call and the date and time it was received. It also contains the Caller's name and phone number (if you subscribe to Verizon Caller ID and the information is available).

Out tab: When the **Out** tab is selected, you have a view of all **Outgoing Calls** and related data. View your most recent 50 Outgoing Calls. Each entry in the Log represents a Call and the date and time it was made.

Voice Mail tab: This feature works with Verizon Voice Mail Service. You must be a current Verizon Home Voice Mail subscriber to use this feature. If you are a current subscriber, select **Set-up**. This will allow you to enter in your Verizon Voice Mail Access Number. Once you have entered your Voice Mail access number and selected **Done** to save, use the **Dial Voice Mail** selection to check your messages. **Note:** You can insert a comma following the access number entry to designate a pause in the number sequence.

For Verizon Home Voice Mail subscribers who also subscribe to the Verizon **iobi Home** service, the Voice Mail tab will display an on-screen visual list of your Voice Mail messages, and you can listen to them in any order.



Verizon One User Guide

19. Touch-Screen Features

19.1.4 Call Log* Features

19.1.4.1 View Caller

The **View Caller** screen allows you to view, call or map a caller and/or Contact. You can also add this caller to your Address Book or update an existing Address Book Contact with call information. Access the **View Caller** screen by selecting a Call in a Call Log.

* Caller ID subscription is required.

Commands & Symbols

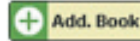

Action

Calls the Contact number displayed.

Calls the contact/number displayed with 1+.

Add this caller to your Address Book (appears if the contact is not in the Address Book).

Update this contact in your Address Book (appears if the contact is already in the Address Book).

Look up origin of a call to locate caller and/or for driving directions.

Delete this Call from your Call Log. Select **Yes** when asked to confirm that you wish to delete.



Verizon One User Guide

19. Touch-Screen Features

19.1.4.2 Update a Contact

On the **Update a Contact** screen, select the Group for the Contact for which you wish to add this phone number. Enter or update a Contact Name and select a phone number **Type**. Select **Done** to save your changes.

19.1.4.3 Map a Caller

The **Map a Caller** screen shows a map of your Contact's geographical location. You can select **Directions** to get driving directions.



Verizon One User Guide

19. Touch-Screen Features

19.1.5 Receiving an Incoming Call

When you receive a call, **Verizon One** will display the **In Call** screen which displays Caller ID* information (if available). The **In Call** screen also provides screen commands that you can touch with your stylus to answer, route or disconnect an Incoming Call, or perform other phone functions:

Commands & Symbols

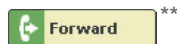
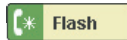
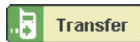

Action

Disconnect the call.

Transfer the call.

Answer Call Waiting or go back to the original call.

Answer a call on speakerphone.

Get a map and/or driving directions for this caller.

Forward a call to Voice Mail.

Indicates that your caller is on Hold. To take a caller off Hold, either select the **Hold** icon or press the **Hold** button on the Base.

Indicates that your caller is on Mute. (Person you called cannot hear you). To take a caller off Mute, either select the **Mute** icon or press the **Mute** button on the Base.

*Caller ID subscription is required.

**Available to Verizon Home Voice Mail subscribers only.



Verizon One User Guide

19. Touch-Screen Features

19.1.6 Placing an Outgoing Call

In addition to the outgoing call methods described in the Handset and Base sections, you may also make a phone call using the touch-screen or a combination of touch-screen commands with Base buttons.

To place a call:

1. Dial a Phone Number on the Base keypad. The **Dialer** screen appears on your touch-screen.
2. Select **Dial**. The call is placed. The **In Call** screen appears.
3. Select **End Call** to disconnect at any time.

Options on the Dialer Screen when you are Off-Hook but have not yet entered a number:

Commands & Symbols

Speed Dial



Emergency

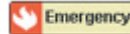

Information



End Call



Action

Access your saved Speed Dial List.

Access your Emergency Numbers.

Dial 411 for Directory Assistance.

Disconnect the call.

Options on the Dialer Screen when you are Off-Hook and have entered a number:

Commands & Symbols

Add Number



Add Memo

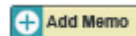

Map



End Call



Action

Add this number to your Address Book.

Access the Add Memo Screen.

Get a map and/or driving directions for the location of this number.

Disconnect the call.



Verizon One User Guide

19. Touch-Screen Features

19.2 Voice Mail





The Voice Mail tab works with Verizon Voice Mail Service. You must be a current Verizon Home Voice Mail subscriber to use this feature. If you are a current subscriber, select **Set-up**. This will allow you to enter in your Verizon Voice Mail Access Number. Once you have entered your Voice Mail access number and selected **Done** to save, use the **Dial Voice Mail** selection to check your messages. **Note:** You can insert a comma following the access number entry to designate a pause in the number sequence.

For Verizon Home Voice Mail subscribers who also subscribe to the Verizon **iobi Home** service, the Voice Mail tab will display an on-screen visual list of your Voice Mail messages, and you can listen to them in any order.

19.3 Speed Dial

One-touch dial a phone number from a list of your saved Speed Dial positions.

19.3.1 Add a Contact to Your Speed Dial List

1. Select Speed Dial  from the Menu.
2. On the Speed Dial screen, select  to go to the **Emergency Numbers** screen or pick an “empty” **Dial position** from 1-9 to add a Speed Dial (e.g. ).
3. On the entry screen for this Speed Dial position, select  or touch the entry field to access the keyboard to enter the **Name** and **Phone Number** of the person or business you would like to add to your Speed Dial list.

The position number at the top of the screen will be the Speed Dial number for this person or business from now on (unless you choose to change this entry in the future).

Tip: When entering a phone number on the keypad, use **ONLY** ten digits (area code + phone number). Do **NOT** enter a “1” before the area code.



Verizon One User Guide

19. Touch-Screen Features

19.3.2 Edit a Contact on Your Speed Dial List

1. Select **Speed Dial**  from the Menu.
2. Touch the Name of the entry you wish to update.
3. On the entry screen for this Speed Dial position, select or touch the entry field to access the keyboard to update the **Name** and **Phone Number** fields.
4. Select **Done** to save your changes and return to the **Speed Dial** page.

19.3.3 Dial a Contact on Your Speed Dial List

1. Select **Speed Dial**  from the Menu.
2. Select the **Dial** icon next to the **Speed Dial** number you want to dial to initiate the call.

19.4 Emergency Numbers

View your list of saved emergency phone numbers on the Emergency Number screen. Police, Fire, Hospital, Doctor and Poison are default placeholders that you may populate with the appropriate phone numbers.

- Select  to dial an Emergency number.
- Select **Add** to add a new Emergency number. Select an Emergency number on the list to update or change information.

19.4.1 Add an Emergency Number

1. Enter a **Name** and **Phone Number** - for the number you are adding to your Emergency list - on the **Emergency - Add Entry** screen.
2. Select **Done** to save your changes.

19.4.2 Edit an Existing Emergency Number

1. Edit your Emergency contact's **Name** and **Phone Number** on the **Emergency - Edit Entry** screen.
2. Select **Done** to save your changes. To delete this Emergency number, select **Delete**.



Verizon One User Guide

19. Touch-Screen Features

19.5 Address Book

Access and manage your online Address Book and directly place calls from it. Your Address Book may contain Personal Contacts, Business Contacts and Groups. You may assign Contacts to Groups for quick access.

View Contacts

Select **Address Book**  from the Menu.

The **Address Book** screen appears. This screen displays a list of people in your Address Book. Use the scroll bar at the right to navigate through the entire list. The default view is an alphabetical list of all of your Contacts.



Filter Contact List

To filter and view only the Contacts from

a specific Group, select a **Group** from the drop down menu. For example, select **Work** to view only the Contacts you have placed in the Group named **Work**.

To view your Contacts alphabetically, select from the **A-F**, **G-L**, **M-S**, or **T-Z** buttons to advance the list accordingly. When you find the Contact that you're looking for, select it by touching the Contact listing (anywhere except on the Dial button). Select **Add** to Add a Contact to your Address Book.

19.5.1 Calling a Contact from your Address Book

You may call a Contact from the **View Contact - Numbers** screen. Select a phone number from the menu, then select  or  (when the call requires dialing a "1").

- Select **Address Book** to view address and location information for this Contact.
- Select **Speed Dial** to add this Contact to your Speed Dial list.

Note: The **Speed Dial** button appears only if the phone number selected is NOT stored in your **Verizon One** Speed Dial already. Speed Dial maximum is 9.

- Select **Edit Contact** to update information for this Contact.
- Select **Delete** to permanently delete this Contact from your Address Book. You will be asked to confirm: select **Yes** or **No** to either complete or cancel your delete Contact request.
- Select **Back** to return to the **Address Book** screen (list of Contacts).



Verizon One User Guide

19. Touch-Screen Features

19.5.2 Get Address, Map and Directions

The **View Contact – Addresses** screen displays the Addresses stored for the selected Contact. Under the Contact Name is the E-mail and Home Address.

- Select **Map** for a map of the Home Address.
- Select **Numbers** to go to the **View Contact – Numbers** screen for dialing and other options and information for the Contact.
- Select **Edit Contact** to update information for the Contact.
- Select **Delete** to permanently delete the Contact from your Address Book (you will be asked to confirm: select **Yes** or **No** to either complete or cancel your delete Contact request).
- Select **Back** to return to the **Address Book** screen (list of Contacts).

19.5.3 Adding Contacts to Your Address Book

On the **Address Book - Add Entry** screen, indicate the type of Address Book entry you wish to add by selecting **Add a Person, Add a Business or Add a Group**.

19.5.3.1 Add a Person

1. Select **Address Book**  from the Menu.
2. Select **Add** from the **Address Book** screen.
3. Select **Add a Person**.
4. On the **Add Contact - Required Information** screen, enter **First Name, Last Name, Nickname** and **Primary Phone** and select a **Primary Phone Number** type from the **Type** menu.

5. Select **More** to complete the rest of the **Add Contact** wizard.

Tip: You can complete the Address Book **Add a Contact** wizard by selecting **More** upon completing each screen. Or, you can select **Done** on any screen to save your information and exit the **Add a Contact** wizard and return to the **Address Book** screen.

6. On the **Add Contact - Home Numbers** screen, enter **Phone, Cell, Fax** and/or **Pager** numbers. Select **More** to advance to the **Add Contact - Work Numbers** screen.



Verizon One User Guide

19. Touch-Screen Features

19.5.3.1 Add a Person (cont'd)

7. On the **Add Contact - Work Numbers** Add **Work Numbers** screen, enter work **Phone**, **Cell**, **Fax** and/or **Pager** numbers. Select **More** to advance to the **New Contact - Home Address** screen.
8. On the **Add Contact - Home Address** screen, enter street **Address**, **City**, **State**, **ZIP** and **Country**. Select **More** to advance to the **New Contact - Work Address** screen.
9. On the **Add Contact - Work Address** screen, Add **Street**, **City**, **State**, **ZIP** and **Country**. Select **More** to advance to the **Add Contact - Internet** screen.
10. On the **Add Contact - Internet** screen, Add **Home E-mail** and **Work E-mail** addresses. Select **More** to advance to the **Add Contact - Group** screen.

Select **More** to advance to select a **Group**.

11. On the **Add Contact - Group** screen, select a **Group** from the menu to add this contact to. Select a photo from the the *Picture* menu for a Contact. Select **Done** to save your information and exit the **Add a Contact** wizard.

Tip: You can navigate back to previous screens by selecting **Back**. Select **Cancel** to exit without saving the information you entered.

19.5.3.2 Delete a Person

1. Select **Address Book**  from the Menu.
2. Select a Contact from the **Address Book** screen.
3. Select **Delete** from the **View Contact - Numbers** screen.

4. Confirm: select **Yes** or **No** to complete or cancel your delete Contact request.

19.5.3.3 Add a Business Contact

1. Select Address Book  from the Menu.
2. Select **Add** from the **Address Book** screen.
3. Select **Add a Business**.
4. On the **Edit Contact - Required Information** screen, enter **First Name**, **Last Name**, **Nickname**, and a **Primary Phone Number**.

Tip: You can select **Done** on any screen to save your information and exit the **Add a Contact** wizard. You may also navigate back to previous screens by selecting **Back**. You can skip screens or advance by selecting **More**.



Verizon One User Guide

19. Touch-Screen Features

19.5.3.3 Add a Business Contact (cont'd)

5. On the **Add Business Contact - Required Information** screen, enter **Name**, **Primary Phone Number** and select **Phone** or **Cell** from the **Type** menu. Select **More** to advance to the **Add Business - Numbers** screen.

Tip: You can complete the Address Book **Add a Contact** wizard by selecting **More** upon completing each screen.

19.5.3.4 Add a Group

1. Select **Address Book**  from the Menu.
2. Select **Add** from the **Address Book** screen.
3. Select **Add a Group**.

Now you can add Personal and Business Contacts to this Group on the **Add/Edit Contact - Group** screens.

19.6 Calendar

Schedule and manage your daily activities, make task lists and schedule Call Forwarding ahead of time.

19.6.1 Access Your Calendar

Select Calendar from the Menu. The **Calendar** screen appears.

19.6.2 View Your Calendar

1. Select Calendar  from the Menu. The **Calendar** screen appears. Shaded dates in **Month** view indicate a scheduled Event(s) for that day.
2. To view an existing Event, select the day on the **Month** view.

3. Select the **Day** tab.
4. Select an **Event** to view its details.

The **Calendar - Event Detail** screen displays your **Event** and related information. To update or edit Event details, select **Edit**.

You can also:



- Select the **Month**, **Day** or **Week** tab to select a Calendar view.
- Select the back or forward arrow to go to the previous—or move to the next—Month, Day or Week.
- Select **Add** to add an Event to your Calendar.
- Select **View Tasks** to view your Task list.
- Select the back or forward arrow at the top to go to the previous—or move to the next— **Month**, **Day** or **Week**.



19. Touch-Screen Features

19.6.3. Appointments

19.6.3.1 Add an Appointment

1. Select **Calendar**  from the Menu.
2. Select **Add** on the **Calendar** screen.
3. Select **Appointment** .
4. On the **Calendar - Add Appointment** screen, enter **Subject** and **Location**.

Tip: Select  or touch an entry field to access the keyboard.

5. Touch the **Start** entry field for the **Select Date and Time** screen.
6. Choose a **Start Date** by touching a day from the **Monthly** calendar view. You may back up or advance a month by touching the arrow buttons.
7. Choose a **Start Time** (check **All-Day Appointment** if applicable).

8. Select **Enter** to accept your **Time** and **Date** selections and return to the **Calendar – Add Event** screen.
9. Touch the **End** entry field for the **Select Date and Time** screen.
10. Choose an **End Date** by touching a day from the **Monthly** calendar view.
11. Choose an **End Time** (check **All-Day Event** if applicable).
12. Select **Enter** to accept your **Time** and **Date** selections and return to the **Calendar – Add Event** screen.
13. Select **More** to set a Reminder.
14. On the next screen, select a lead-time for On the next screen select a lead-time for an **Appointment Reminder** if you'd like to have a reminder before the time and date of the **Appointment**. **Verizon One** will remind you through an audio

alert, in addition to delivering a reminder message on the touch-screen display. If you do not want a reminder, select **None** from the **Reminder** menu. If you do not want a reminder, select **None** from the **Reminder** menu.

If you intend for the appointment to recur, select **Daily**, **Weekly**, **Monthly** or **Yearly** from the **Repeats** menu. If the Appointment you are creating is NOT a recurring appointment, select **None** from the **Repeats** menu (default). Unless you selected **None** (for a one-time Appointment), enter a date for this Appointment to **Stop Repeating**.

Select **Done** to save the Appointment and return to the Calendar screen. Select **Back** to return to the previous screen. Select **Cancel** to exit without saving.



Verizon One User Guide

19. Touch-Screen Features

19.6.3.2 Edit an Appointment

1. Select **Calendar**  from the Menu.
2. Select the day of the Appointment you wish to edit.
3. Select the **Day** tab.
4. Select the Appointment that you wish to edit.
5. Select **Edit**.
6. Update **Subject, Location, Start** and **End** fields as needed. Select **More**.
7. Update **Reminder, Repeats** and **Stop Repeating** fields as needed. Select **Done** to save your updates.

Important! When you **Edit** an Appointment on **Verizon One**, change(s) are saved to the entire series. Updates to only one instance of a **Repeating Appointment** must be performed on the Web.

19.6.3.3 Delete an Event

1. Select **Calendar**  from the Menu.
2. Select the day of the **Appointment** you wish to edit.
3. Select the **Day** tab.
4. Select the **Appointment** that you wish to Delete.
5. Select **Delete**. Confirm: Yes or No.



Important! When you **Delete** a **Repeating Appointment** on **Verizon One**, the entire series is permanently deleted. Deletion of only one instance of a **Repeating Appointment** must be performed on the Web.



19. Touch-Screen Features

19.6.4 Tasks

19.6.4.1 Add a Task

1. Select **Calendar**  from the Menu.
2. Select **Add** on the **Calendar** screen.
3. Select Task .
4. On the **Calendar - Add Task** screen, enter **Subject** (name for this new Task).
5. Select Task **Priority** (High, Low or Normal) from the menu. This can be edited as needed.
6. Touch the **Due Date** entry field for the Select Date screen.
7. Choose a **Due Date** by touching a day on the **Monthly** calendar.
8. Select **Enter** to accept your Due Date selection and return to the **Calendar - Add Task** screen.

Note: Select the **Completed** check box to indicate that a Task is complete. You can also select a checked box to change the **Status** from **Completed** back to pending.

9. Select **Done** to save the Task and return to the Calendar screen.

19.6.4.2 Edit a Task

1. Select **Calendar**  from the Menu.
2. Select **View Tasks** on the **Calendar** screen.
3. Select the **Task** that you wish to edit.
4. Select **Edit** on the **Calendar - Task Detail** screen.
5. Edit the **Subject** as needed by touching the entry field.

6. Edit the **Priority** (High, Low or Normal from the menu) as needed.
7. Select the **Completed** check box to indicate that a Task is complete. You can also select a checked box to change the **Status** from **Completed** back to pending.
8. Edit the **Due Date** by touching the entry field for the **Calendar - Select Date** screen. Make the necessary changes. Select **Enter** to return to the **Calendar - Edit Task** screen.
9. Select **Done** when your changes are complete.



19. Touch-Screen Features

19.6.4.3 View Tasks

1. Select **Calendar**  from the Menu.
2. Select **View Tasks** on the **Calendar** screen. The **Calendar – Tasks** screen appears.

The **Calendar – Task** screen lists all of your saved Tasks, each with **Status** and **Due Date**. Also:

- Select a Task for the **Calendar – Task Detail** screen where you can Edit or Delete the Task.
- Select **Delete All** to delete all tasks from your Calendar. You will be asked to confirm: select **Yes** or **No** to either complete or cancel your **Delete All Tasks** request.
- Select **Back** to return to the **Calendar** screen.

Tip: To Delete only one specific Task rather than ALL Tasks, touch the specific

Task on the **Calendar – Task** screen and select **Delete** on the **Calendar – Task Detail** screen.

19.7 Memos

Use a freestyle memo pad (using the stylus on the touch-screen) to jot down numbers or leave notes for other household members.

Tip: When you see  on the Home screen, you have a new Memo waiting for you.

19.7.1 Memo Screen

The **Memo** screen lists all of your Memos (holds up to 10). Selecting **Date** (default) or **Name** from the menu lets you sort by date or who the memo is **For**. Select one of the Memos on the list to view it.

You can also select **Add** to add a new memo, or **Delete All** to delete all memos.

When deleting, select **Yes** when asked to confirm that you wish to delete.

19.7.2 View a Memo

The **Memo - View Memo** screen is where you can view a memo and the time and date that it was left for you. Touch **Delete** when you no longer need to save this memo.

19.7.3 Add a Memo

In the **For entry** field on the **Memo - Add Memo** screen, enter the name of the person who the new memo is for. You can then use the stylus to write your message. Or follow the instructions below to enter text, select pen colors and widths, background colors, even add expressions. When you are done with your memo creation, touch **Done** to save the memo or **Cancel** to exit the memo without saving.





Verizon One User Guide

19. Touch-Screen Features

19.7.3 Add a Memo (cont'd)

To use the keyboard to enter printed text in the drawing area:

1. Choose the text color by selecting the **Pen Color** . A pop-up menu with available colors will appear. The currently selected color is outlined. Select the color you would like your text to be, and the menu will close.
2. Select **Text** . Touch any point in the drawing area where you would like your text to begin. The keyboard will then appear. Type your message and touch **Enter**. The text will appear in the memo with your selected color.

To change the color of the background of your memo:

1. Select **Background** . A pop-up menu with available colors will appear.

2. Select the background color of your choice from the available color options and the menu will close. Your background color will be changed.

To change the color of the pen when drawing lines:

1. Select **Pen Color** . A pop-up menu with available colors will appear. The currently selected color is highlighted.
2. Select the color you would like your pen to be and the menu will close. All new drawings will appear in the newly selected color.

To change the width of the pen for drawing:

1. Touch and hold the **Pen Width** . A pop-up menu will appear, showing available widths to choose from. The currently selected width is outlined.

2. Select the width and the menu will close. All new drawings will be the width you selected.

To place a pre-defined expression onto the drawing area:

1. Select **Expressions** . A pop-up menu will appear with a series of expressions to choose from.
2. Select an expression of your choice. Touch the location in the drawing area where you would like to place it. Your selected expression will be drawn.

Tip: When placing an expression on a memo, if you touch, hold and drag, you can adjust its location. This can only be done when you first place it on the memo.





Verizon One User Guide

19. Touch-Screen Features

19.7.3 Add a Memo (cont'd)

To erase portions of the drawing area:

1. Select **Eraser** . Your cursor will turn into a rectangle. Touch any point of the drawing area and drag. Anything underneath the rectangle will be erased (with the exception of the background color).
2. Select **Pen Width** again to return to the pen function.

Tip: To erase the whole area, touch and hold **Eraser**  and select **All** from the pop-up menu.

To change the size of the area the eraser will cover:

1. Touch and hold the **Eraser** . A pop-up menu will appear with available sizes to choose from.

The currently selected size is outlined.

2. Select the size, and the menu will close. Touch any point in the drawing area and drag. Your eraser will be the size you selected.

To erase everything on the memo, but keep the background color:

1. Touch and hold the **Eraser** . A pop-up menu will appear.
2. Select the **All** option. All information will be erased, but the background color will remain.

19.9 SuperPages

Verizon One gives you select-screen access to Verizon SuperPages so you can look up a residential or business listing and direct dial it with one touch. Also access maps and directions.

19.9.1 Look Up a Business

1. Select **SuperPages**  from the Menu.
2. Select **Yellow Pages** to look up a business.
3. Enter **Keyword** or **Business Name**.
4. Enter **City**.
5. Enter **State**.
6. Select **Find It**. The results of your search will appear on the SuperPages - Search Results screen.



Verizon One User Guide

19. Touch-Screen Features

19.9.1 Look Up a Business (*cont'd*)

Tip: Select **Categories** to look up a business by category. Once you have reached the most specific level for your category selection (e.g. Art Galleries or Boat Rentals), enter your **City** and **State** and select **Find It**.

19.9.2 Look Up a Person

1. Select **SuperPages**  from the Menu.
2. Select **White Pages** to look up a person.
3. Enter **First Name**.
4. Enter **Last Name** (required).
5. Enter **City**.
6. Enter **State**.
7. Select **Find It**. The results of your search will appear on the **SuperPages - Search Results** screen.

19.9.3 Reverse Lookup





1. Select **SuperPages**  from the Menu.
2. Select **Reverse Lookup** to look up a person or business with their phone number.
3. Enter **Area Code** and **Phone Number**. Select **Find It**. The results of your search will appear on the **SuperPages - Search Results** screen.





19. Touch-Screen Features

19.9.4 Search Results

Not only does the **SuperPages - Search Results** screen display the results of your **SuperPages** search, it is also your link to one-touch dialing, **Maps** and **Driving Directions**.

- Select **New Search** to start your search over.
- Select  to call your Contact.
- Select  to call your Contact when the call requires dialing a "1".
- Select  for a map and driving directions.
- Select  to add this person to your Address Book.

19.9.4.1 SuperPages - Map

1. Select **SuperPages**  from the Menu.
2. Conduct a search by selecting one of the following: **Business**, **Person** or **Reverse Lookup**. Enter parameters requested on the next screen, and select **Find It**.
3. From the **SuperPages - Search Results** screen, select .

The map that appears matches the search result that you selected on the previous screen. Select **Back** to return to Search Results. Select **Directions** for driving directions:

1. On the **SuperPages - Directions** screen, enter the starting point from which you want Driving Directions: Enter **Address**, **City**, **State** and **ZIP**.

2. Select the **Save Address** check box if you wish to save this Address for future Driving Directions requests.
3. Select **Show**. Directions for driving to your Search Result location will appear.

Tip: The address at the top of the **Directions** screens is that of the Search Result selected.





Verizon One User Guide

19. Touch-Screen Features

19.9.4.2 Add a SuperPages Search Results Number to Your Address Book

To add a Phone Number from **SuperPages Search Results** to your Address Book:

1. Select **SuperPages**  from the Menu.
2. Conduct a search by selecting one of the following: **Business**, **Person** or **Reverse Lookup**. Enter parameters on the next screen. Select **Find It**.
3. From the **SuperPages - Search Results** screen, select  to add this party to your Address Book.

The **Add Contact – Required** screen appears with the SuperPages Contact/Business information pre-populated for you.



4. Edit the information as needed.
5. Add additional information by selecting **More** to access more **Add a Contact** wizard screens. Select **Done** to save your new Address Book entry.

19.10 E-Mail

You can check and send E-Mail directly from the **Verizon One** device.

Note: To use the Mobile E-Mail feature, you will need a Verizon Online e-mail account. Go to www.verizon.com/iobi to set it up.

19.10.1 Setup E-Mail

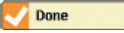
1. Select **Menu** .
2. Use the scroll bar to find E-Mail and select .
3. Select  to enter your **Verizon Online** E-Mail password.
4. Select  to check your E-Mail messages.

If you've forgotten your password, go to <http://dslstart.verizon.net> to find it.

If you don't have a Verizon Online e-mail account, go to www.verizon.com/iobi to set it up.







Verizon One User Guide

19. Touch-Screen Features

19.10.2 Check E-Mail

1. Select  to enter your Verizon Online E-Mail password.
Forgot password? Go to dslstart.verizon.net for help.
2. Use the scroll bar to view your list of E-Mail messages.
3. Select the E-Mail you want to view.







19.10.3 Reply to an E-Mail

1. Use the scroll bar to view your list of E-Mail messages.
2. Select the E-Mail you want to view.
3. Select  to write a message to the sender. Select  to write a message to all recipients.
4. Select  to enter a message.
5. Select .





19.11 Alarm/Timer

You can use **Verizon One** to set a timer, set an alarm or time something with the stopwatch.

19.11.1 Start Timer

1. Select  to use the Timer feature.
2. Select  and  next to Hour, Min or Sec to select a time frame.
3. Select  to start the countdown.
4. An alert will sound and appear on screen when time runs out. Select  to turn the alert off.
5. Select  to stop the countdown.

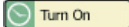
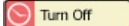
19.11.2 Set Alarm

1. Select  to use the Alarm feature.
2. Select  and  next to Hour, Min or Sec to choose what time you want the Alarm to sound.
3. Select  to turn on the Alarm. An alert will sound and appear on screen when it's time for the Alarm to go off.
4. Select  to turn off the Alarm.
5. When it sounds, select  to turn the alert off. Select  to set the alarm to go off in another 10 minutes.



Verizon One User Guide

19. Touch-Screen Features

19.11.3 Start Stopwatch

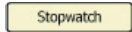
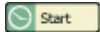
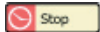
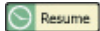
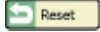
1. Select  to use the stopwatch feature.
2. Select  to begin the Stopwatch.
3. Select  to pause the Stopwatch.
4. Select  to resume the Stopwatch count.
5. Select  to stop the Stopwatch and reset all counters to 00.

19.12 Calculator

The calculator allows for basic calculation functions of addition, subtraction, multiplication and division.

19.13 News & More

Check local weather and the 5-day forecast, read news and sports headlines, review movie listings, find theaters and show times, get sports scores, watch favorite stocks, read your daily horoscope and locate local restaurants by cuisine type.

Verizon One's News & More contains multiple Content Channels including:

- My Choices
- Entertainment
- Top Headlines
- Lottery
- Movies
- Stocks
- Weather
- SuperPages
- Sports News
- Restaurants
- Scores
- Horoscopes

19.13.1 Choose Content

1. From the Menu, select  **News & More**. The **News & More** screen appears.
2. Select a Content Channel to view.

Tip: You can also access all Content Channels from the **Home** screen by selecting **News and More**.

19.13.1.1 My Choices

Set up your favorite content to rotate every 20 seconds on your Verizon One touch-screen. Go to <https://www36.verizon.com/verizon-one> to customize your choices.

19.13.1.2 Top Headlines

View **News Headlines**. Just select a headline to read the news Story.



19. Touch-Screen Features

19.13.1.3 Movies

Find out what is playing at nearby theaters. Review movie listings and show times.

When you access **Movies** from **News & More** in the Menu, the **Movies - Theaters List** screen appears. Select a theater from the list based on your ZIP code or enter a new **ZIP** and select a **Distance** (how far from that ZIP code you want to travel) from the menu. A list of Theaters based on your new parameters will automatically appear.



The list of Theaters contains the Theater Name. Select a movie theater to view a list of movies playing there.

The **Movies At Theater** screen lists movies for your theater. On this screen:

1. Select a movie to view its rating, release date, show times and brief synopsis. Select **More Info** to read entire synopsis.

2. Select **Theater Info** from the **Movies At Theater** screen to view theater address and phone number.

On the **Movies-Theater Info** screen:

1. Select the  or  icons to call the theater.
2. Select  for the **Map and Driving Directions** screens.

Tip: Once entered, your **ZIP Code** becomes the default until you enter a different one. This means that the theaters in your area always appear automatically. Enter a **ZIP Code** to look up theaters in a different location.

Tip: You can also access **Movies** from the **Home** screen. Select **News & More**, and then select **Movies** from the Summary menu.

19.13.1.4 Weather

When you access **Weather** from **News & More** in the Menu, you are brought to the Weather screen.

19.13.1.4.1 Local Weather

1. View today's local weather and a five-day forecast for your area based upon your ZIP code.
2. Enter a new **ZIP Code** to look up weather for another area.
3. If you are viewing **Today's Weather**, select the **5-Day Forecast** to show the weather forecast for the next 5 days in your area. If you are viewing the **5-Day Forecast**, select **Today's Weather** to see today's more detailed forecast.







Verizon One User Guide

19. Touch-Screen Features





19.13.1.4.1 Local Weather (cont'd)

Tip: Once entered, your **ZIP Code** becomes the default until you enter a different one. This means that the weather for your area appears automatically when you come to the **Weather** screen.

19.13.1.4.2 Radar

1. Open **News & More** and select .
2. Select .
3. Select  to get the Satellite view.
4. Select  to see the Radar animate for the last hour of weather activity.
5. Select  to see the Radar in full-screen.
6. Select the Map to zoom in.

19.13.1.4.3 International Weather

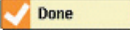
1. Select .
2. Select .
3. Select .
4. Select  to enter a new City and Country.
5. Select  to get the weather for that area.

19.13.1.5 Sports News

View **Sports News** headlines. Just select a headline to view the Story.



19.13.1.6 Scores

Choose from a list of sports to see recent scores.

19.13.1.7 Entertainment

1. Open **News & More** and select .
2. Ten entertainment news headlines are listed and will automatically move through each story.

OR

Select  and  to scroll through the headlines at your own pace.

3. Select  to read the full story.



Verizon One User Guide

19. Touch-Screen Features

19.13.1.8 Lottery



1. Open News & More and select **Lottery** .
2. Lottery results are listed and will automatically move through each item.

OR

Select  and  to scroll through the lotteries.

3. Select  to get Lottery details.

19.13.1.8.1 View Game

1. Select  and  to scroll through the lotteries.
2. Select  to get the Lottery details.

19.13.1.8.2 Change Location

1. Select .
2. Select a State from the list to view the Lotteries.

19.13.1.9 Stocks

Track up to 10 Stocks/Ticker Symbols and use Company Search to look up Ticker Symbols.

To add a Stock Symbol to watch:

1. From the **Stocks** screen, select **Add to** add the ticker symbol for the stock you wish to track.
2. Enter a Ticker Symbol (or enter the company name in the **Don't know the symbol? Find it** field).
3. Select **Search** to look up the Ticker. The **Stocks - Company Search** screen appears.

4. You are returned to the **Stocks** screen where your new symbol now appears in the **Ticker Symbol** field.
5. Select **Done** to add this Symbol to your list of Stocks to track.

Next time you return to **Stocks**, your symbol(s) will appear automatically.

19.13.1.10 SuperPages

See Section **19.9 SuperPages** for steps.



Verizon One User Guide

19. Touch-Screen Features



19.13.1.11 Restaurants

You can lookup restaurants in your area. Your ZIP Code becomes the default until you enter a different one. This means that the restaurants in your area always appear automatically.









19.13.1.11.1 Lookup Restaurants

1. Select **News & More** on the Home screen.
2. Select .
3. 90 Restaurants near you will be listed and will automatically move through each listing.



OR

- Select  and  to scroll through the restaurants at your own pace.
4. Select  to view information about a specific restaurant.

19.13.1.11.2 Change Cuisine

1. Select .
2. Select  to find restaurants that serve a specific cuisine.
3. A list of cuisine choices is offered.
4. Use the scrollbar   to view the entire list.
5. Select a cuisine.
6. All restaurants under that category, sorted by distance, will appear.
7. Select  for restaurant details.
 - Select  to dial the number.
 - Select  to call long distance.
 - Select  to look at a mapped location of this restaurant.
 - Select  to add this restaurant to your business contacts.



19.13.1.11.3 Change Location

1. Select . A list of cuisine choices is offered.
2. Select  to find restaurants within another area.
3. Select the Location field to enter another ZIP code.

OR

Select the Distance field to change the search radius.

19.13.1.11.4 Restaurants Near Me

1. Select . A list of cuisine choices is offered.
2. Select  to find restaurants in your area.



Verizon One User Guide

19. Touch-Screen Features

19.13.1.11.4 Restaurants Near Me (cont'd)

3. This is a list of restaurants near you, based upon the ZIP code and search radius you have entered. The list is sorted by distance, starting with the closest.
4. Select  to learn more about a specific restaurant.
5. To change the ZIP code, select the ZIP code field and use the touchpad to enter a new ZIP code.
6. To change the search radius, select the Distance menu and select a new search radius.

19.13.1.12 Horoscopes

When you access **Horoscopes** from **News & More** in the Main Menu, the **Horoscopes** screen appears. Select

an astrological sign from the list to view the Horoscope. The **Horoscopes – View** screen appears. Here you can read the **Horoscope** for the astrological sign you selected.

Tip: You can also access **Horoscopes** from the **Home** screen. Select **News & More**, and then select **Horoscopes** from the Summary menu.

19.14 Add **iobiSM Home***

Add **iobiSM Home** to take your **Verizon One** to the next level. This section describes additional features you can use on **Verizon One** if you subscribe to **iobi Home**.

Visit www.verizon.com/iobihome to learn more about **iobi Home** or to upgrade today.

Please note: You must subscribe to **iobi Home** service on the same telephone

which is active on your DSL service. This is required in order that the **iobi Home** features described below be accessible on **Verizon One**:

19.14.1 Manage Calls

Manage incoming Calls directly from the **Verizon One** screen. **iobi Home** prompts you when a new call come comes in and lets you **Answer** or **Block Calls**, **Forward**** to another number, or send the call to your **Voice Mail*****.

iobi Home also lets you forward calls from your home phone to another telephone number such as a cellular or work number. You can also create and save a list of different **Destination** numbers that can easily be activated or deactivated. Plus you can set-up a **Call Forwarding** schedule in advance – for regular times when you're away from home.



19. Touch-Screen Features

19.14.1.1 Using Manage Calls

Use the **Manage Calls** screen to turn **Call Management** on or off, start or stop **Call Forwarding**, set-up **Scheduled Call Forwarding** tasks, and manage your **Call Forwarding Destinations** (phone numbers).

Command

Prompt on Incoming Calls	Select check box to (enable) - or uncheck (disable) prompts on incoming calls.
Forward to	Select a destination (number) to which you want your calls forwarded, or add a new Destination number to your saved list.
Start Button	Activate Call Forwarding immediately to the destination (number) selected.
Stop Button	Deactivate Call Forwarding immediately.
Schedule	Schedule Call Forwarding for a later date and time or repeating schedule.
Destinations	Select to add, edit or delete a Call Forwarding Destination (phone number).
Message	Select the message to play to an incoming caller when pressing the "Auto Reply" button on your call prompt screen.



Verizon One User Guide

19. Touch-Screen Features

19.14.1.2 Manage Call Forwarding Destinations (Phone Numbers)

Use the **Destinations** screen to view the numbers you have set-up for **Call Forwarding**. You may add a new Destination by selecting **Add**. To edit an existing Destination, go to **Destinations – Edit Entry** – where you may **Edit** or **Delete** a Destination.

Destinations – Add Entry

Enter a **Name** and **Number** for this Destination. Select **Done** to save the entry.

Destinations – Edit Entry

Edit the **Destination Name** and/or **Number** (by touching the entry to bring up the keyboard) to make changes as needed.

19.14.2 Voice Mail

With **iobi Home**, you'll get a **Verizon One** on-screen list of each Voice Mail message. Instead of dialing into your Voice mailbox, you can now play messages in any order that you choose.

19.14.2.1 Play Messages

By selecting the Voice Mail icon  from **Calls & Memos** or the Menu screen, the Voice Mail tab will provide you with a list of your voice messages and the date and time each Voice Mail was received. By selecting a message, you will be able to **Play** your Voice Mail. You may also **Rewind**, **Pause**, **Forward** or **Delete** the recording at any time.



19.14.2.2 Forward Messages

Selecting the **Forward** option when viewing a Voice Mail allows you to forward the Voice Mail to an E-mail address you specify. Select an E-mail address from your Address Book by selecting from Addresses, or enter a new E-mail address in the other E-mail Address field. Select **Done** to send.



19. Touch-Screen Features

19.14.2.3 Schedule Call Forwarding

1. Select **Calendar**  from the Menu.
2. Select **Add** on the **Calendar** screen.
3. Select **Schedule Call Forwarding**.
4. On the **Calendar – Schedule Call Forwarding** screen, select a phone number to forward to from the **Destination Number** menu – or select **Add New Number**.
5. Touch the **Date** entry field for the **Select Date and Time**  screen.
6. Choose a **Start Date** by touching a day from the **Monthly** calendar view. You may back up or advance a month by touching the arrow buttons.
7. Choose a **Start Time** (check **All-Day Event** if applicable).
8. Select **Enter** to accept your **Time and Date** selections and return to the **Calendar – Add Event** screen.
9. Touch the **End** entry field for the **Select Date and Time**  screen.
10. Choose an **End Date** by touching a date from the **Monthly** calendar view.
11. Choose an **End Time** (check **All-Day Event** if applicable).
12. Select **Enter** to accept your **Time and Date** selections and return to the **Calendar – Add Event** screen.
13. Select **More** to set a **Reminder**.
14. On the next screen, select a lead-time for a **Reminder** if you want to have an Event reminder E-mail sent to you before the time and date of the **Scheduled Call Forwarding** task. The **Reminder** time-frame specifies how much time (from 0 minutes to 2 days) before your **Scheduled Call Forwarding** task for which you wish to receive an E-mail reminder. If you do not want a reminder, select **None** from the **Repeats** menu (default). Unless you selected **None** (for a one-time Event), enter a date for this Event to **Stop Repeating**.
15. Select **Done** to save the **Scheduled Call Forwarding** task and return to the Calendar screen. Select **Cancel** to exit without saving.



Verizon One User Guide

19. Touch-Screen Features

19.14.2.4 Edit Scheduled Call Forwarding

1. Select **Calendar**  from the Menu.
2. Select the day of the **Scheduled Call Forwarding** task you wish to edit.
3. Select the **Day** tab.
4. Select the **Scheduled Call Forwarding** task that you wish to edit.
5. Select **Destinations – Edit Entry**.
6. Update the **Destination Number** from the menu as needed.
7. Edit the **Start Date** and **End Date** as needed.
8. Select **More** to continue editing this **Scheduled Call Forwarding** task.
9. Continue editing this **Scheduled Call Forwarding** task by editing **Repeat Pattern** as needed.

10. Edit the **Date** and **Time** to **Stop Repeating** as needed.

11. Select **Done** to save changes.

Tip: Select **Delete** to permanently delete a **Scheduled Call Forwarding** task.

* **iobi Home** provided by Verizon Long Distance (“Verizon”) and subject to terms and conditions. **iobi Home** is not compatible with MacIntosh computers. Verizon is not responsible for messages that are lost or delayed due to transmission via the Internet. Information sent via the Internet, including E-mail and Text Messages, is not secure and may be intercepted by third parties during transmission. Verizon is not responsible for the content of messages sent via the E-mail feature. **iobi Home** may not be used for any unlawful purpose, such as sending unsolicited commercial E-mail messages (i.e. spamming). Recipient is responsible for the cost of receiving Text Messages, if any. Taxes and other charges apply.

**Charges for forwarded calls will be billed by the carrier that carries the forwarded calls. Calls may not be forwarded to an international number.

***You must subscribe to a compatible version of Verizon Home Voice Mail (sold separately) to access the Voice Mail features of **iobi Home**.



Verizon One User Guide

19. Touch-Screen Features

19.15 Phone Tips

Reference dialing shortcuts that you can use for common phone shortcuts – such as dialing the last person who called you (*69), or disabling Call Waiting (*70).

19.16 Settings

Select a button for one of the **Settings** categories to setup or change **Verizon One** settings.

19.16.1 Date/Time

Date and Time information was set when you went through the **Verizon One** setup process. Once connected to an active DSL connection, **Verizon One** will automatically synchronize the date and time for you. However, you may adjust your **Time Zone** at any time on the **Settings - Date/Time** screen.

1. Select **Settings**  from the Menu.
2. Select your **Time Zone** from the **Time Zone** drop down menu.
3. Select **Done** to save changes and return to the **Settings** screen, or **Cancel** to exit without saving your change.

19.16.2 Screen Saver

You have the option to choose your Screen Saver for the touch-screen:

1. Select **Settings**  from the Menu.
2. Select **Screen Saver** from the **Settings** screen.

Select a Delay time from the **Delay** menu. This is how long your **Verizon One** display screen can be inactive before your Screen Saver activates.
3. Select a **Screen Saver** from the Screen Saver menu.
4. Select **Preview** to see how the Screen Saver you chose will look. Select **Done** to save your settings.



Verizon One User Guide

19. Touch-Screen Features

19.16.3 Display



Choose brightness, contrast and **Home** screen background on the **Settings-Display** screen:

1. Select **Settings**  from the Menu.
2. Select **Display** from the **Settings** screen.
3. Slide the **Brightness** horizontal slider to adjust your display brightness.
4. Slide the **Contrast** horizontal slider to adjust your display contrast.
5. Select **Change Background** for a selection of pictures.
6. Select the picture you wish to use as your new Background. You will be automatically returned to the **Settings – Display** screen where a thumbnail of your selected photo will appear.

Select **Calibration** to have your display screen checked and adjusted if necessary. Select **Done** to save your settings.

19.16.4 Voice Mail*



The **Settings-Voice Mail** screen is where you access settings related to your Voice Mail:

1. Select **Voice Mail**  from the Menu.
2. Select  or touch the entry field to access the keyboard.
3. Enter your **Voice Mail Access Phone Number** to your Verizon Home Voice Mail service. Select **Done** to save your settings and return to the **Settings** page.

19.16.5 Cell Phones

You can register one or more of your cell phones so you can upload photos from your cell phone to use as a background or screen saver on **Verizon One**.

19.16.5.1 Manage Cell Phones

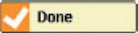
1. Select .
2. A list of registered cell phones will appear.
3. Select the name of the cell phone you want to manage.
4. Select  or select the entry field to change the name of the cell phone.
5. Select  to save your information.



*Available to Verizon Home Voice Mail subscribers only.



Verizon One User Guide

19. Touch-Screen Features

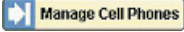
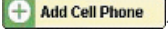
19.16.5.2 Add Cell Phones

1. Select .
2. Select .
3. Select  or touch the entry field to enter the Name and Number of the cell phone.
4. Select  to move to next screen.
5. A text message containing an authorization code will be sent to this cell phone number.
6. You must enter this code from the Manage Cell Phones screen to finalize the authorization.

19.16.5.2.1 Authorizing a Cell Phone

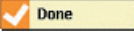
1. Select the cell phone you want to authorize. It will be listed as "Pending".
2. Select  or touch the entry field to enter the authorization code.
3. Select  to move to next screen.
4. You can now upload photos from your cell phone to use as a background or screen saver on **Verizon One**.
5. Send a photo to vzonepix@verizon.com
 - To make it your background, insert a "!" anywhere in the subject line.
 - To make it part of your slideshow, insert a "@" anywhere in the subject line.

If left blank, the photo will become part of "My Pictures".

19.16.5.3 View Cell Phone

Select **Cell Phones** .

19.16.6 Home Networking

See **Section 20 Home Networking** for steps.





Verizon One User Guide

19. Touch-Screen Features



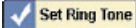
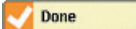

19.16.7 Ring Tones

You can choose from a list of Ring Tones for your **Verizon One**. You can even download new Ring Tones directly to the device.



19.16.7.1 Set Ring Tone

1. Open Settings.
2. Select  to select a ring tone for incoming calls.
3. A list of Ring Tones will appear. Select  to preview the ring.
4. Select  to select this ring tone for incoming calls.
5. Select  to save your settings and return to the Settings page.

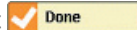
19.16.7.2 View Ring Tones

1. Select .
2. Select  to preview Ring Tones.
3. Select  to stop the preview of the Ring Tone.
4. Select  to select this ring tone for incoming calls.
5. Select  to save your settings and return to the Settings page.

19.16.8 Volume

1. Volume Control is located in the bottom-right of the Home screen.
2. Select  to turn the volume Up or Down.
3.  indicates that the **Verizon One** device is muted.





Verizon One User Guide

19. Touch-Screen Features

19.16.9 Handsets

If you have more than one handset associated with your **Verizon One** device, you can register them, assign a name or edit their settings at any time.

19.16.9.1 Name Handsets

1. Select  Handset1, Handset2, Handset3 or Handset4 to make changes to the handset.
2. Select  or touch the entry field to change the name of the handset. (Ex: Kitchen, TV Room, Master, Guest Room)

Note: The handset must be in the cradle on the **Verizon One** base to change its name.

OR

Select  **Unregister** to disassociate the handset from **Verizon One**.

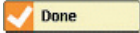

3. Select  **Done** to save your settings and return to the Settings page.

Note: It may take up to 5 seconds for the name change to take effect.

19.16.9.2 Register Handsets

1. Select  **Register Handset**.
2. On the handset, press Menu.
3. Scroll down to Registration and touch Select.
4. Press and hold the Intercom button on the **Verizon One** base until "Wait Registering..." appears on your handset's screen.
5. Registration is complete.

19.16.9.3 Edit Handsets

1. Select  Handset1, Handset2, Handset3 or Handset4 to make changes to the handset.
2. Select  or touch the entry field to change the name of the handset. (Ex: Kitchen, TV Room, Master, Guest Room)

Note: The handset must be in the cradle on the **Verizon One** base to change its name.

OR

Select  **Unregister** to disassociate the handset from **Verizon One**.

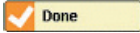
3. Select  **Done** to save your settings and return to the Settings page.

Note: It may take up to 5 seconds for the name change to take effect.



Verizon One User Guide





19. Touch-Screen Features

19.16.10 Shortcuts



You can create Shortcuts to features from the Home screen. Just choose the features you want at-hand.

19.16.10.1 View Shortcuts

Shortcuts are Features listed on your Home screen for easy access.

1. Select  to open your Shortcuts.
2. Select  to move the list of Shortcuts to the Right.
3. Select  to move the list of Shortcuts to the Left.
4. Select the Feature icon to open it.
5. Select  to close your Shortcuts.

19.16.10.2 Choose Shortcuts

1. Open the Menu and Select .
2. Select **Shortcuts** .
3. Select a Feature to select it as a Shortcut.

Note: Selecting a Feature that's already selected will remove it from the Shortcut list.

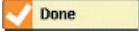
4. Select  to save your Shortcuts.

19.16.12 System Info

The **Settings – System Information** screen allows you to view details of system updates to your **Verizon One** and **iobi Home** services:

1. Select **Settings**  from the Menu.
2. Select **System Info** from the **Settings** screen.
3. Select **Updates** to view notices of updates to your **Verizon One** and **iobi Home** services (as applicable if subscribed to **iobi Home**).
4. Select **Version Info** to verify the **Verizon One** software version installed. Select **Back** to return to the **Settings** screen.



Verizon One User Guide

20. Home Networking

20.1 What is Home Networking

A Home Network connects computers in a household that share an Internet connection, printers, files, and other hardware devices like scanners and DVD burners. Home networks eliminate the need to purchase separate Internet connections and hardware devices for each computer.

With a Home Network, you can share documents, digital photos, and other files between computers (without using floppy discs or CDs). You can keep a central schedule that can be accessed and updated by each member of the household; play multi-user games; and use one central computer to store pictures, videos, and other multimedia files that can be accessed from any computer on the network.

Types of Home Networks:

- **Wired networks:** Require Ethernet cables to transport the data between the computers and the router. (Technical: 10/100 Base-T Ethernet).
- **Wireless networks:** Eliminate the need for cables because radio frequency signals are used to transport data between devices, even if they are in different rooms. (Technical: IEEE 802.11b/g/g+).

For additional information on the **benefits** of Home Networking:

1. Visit <http://dslstart.verizon.net>
2. Select **Help & Support**
3. Select **Home Networking**

20.2 Important Information About Your Verizon One Home Network

If you are planning to use **Verizon One** for Home Networking, we strongly recommend that you complete your DSL Installation before setting up your Wireless Home Network.

Your **Verizon One** is equipped with a **Westell VersaLink™ Gateway** - a combination DSL modem and wireless router which allows you to share a single DSL connection among multiple computers, printers, and digital cameras, etc. within your home. Multiple users can share the connection using (Wireless) IEEE 802.11b/g/g+ and (Wired) 10/100 Base-T Ethernet connections.



Verizon One User Guide

20. Home Networking

20.2 Important Information About Your Verizon One Home Network (cont'd)

Note: Hereafter, the **Verizon One** Communications Subsystem will be referred to as “**Verizon One**,” “Gateway,” or “Modem.”

Your **Verizon One** Wireless Home Network was shipped to you disabled (turned OFF). Enable (turn ON) your Wireless Network by:

1. Selecting **Menu** on the **Verizon One** touch-screen display
2. Select **Settings**
3. Select **Wireless**

The Wireless Network screen on the **Verizon One** touch-screen display will also allow you to create your Wireless Network Name (called a Service Set ID or **SSID**). The default SSID for **Verizon One** is: **Verizon One followed by the last 4-digits of the unit's serial number** (located below the bar code on the bottom of the unit). For example: VerizonOne1234.

20.3 Installing Your Verizon One Home Network

This section explains how to install your Verizon One Home Network:

- Home Networking System Requirements – See Section 20.3.1
- **Verizon One** LED Indicators – See Section 20.3.2
- **Verizon One** Interface Descriptions – See Section 20.3.3
- Installing a Wired Network – See Section 20.3.4
- Installing a Wireless Network – See Section 20.3.5
- Installing both a Wired and a Wireless network simultaneously – See Section 20.3.6



Verizon One User Guide

20. Home Networking

20.3.1 Home Networking System Requirements

The following system specifications are required for optimum performance of **Verizon One** via Wired or Wireless installations. These requirements are applicable to all computers you wish to add to your Home Network now or in the future:

Connection Type

Minimum System Requirements

WIRED

- Pentium® or equivalent and above class machines, Macintosh®
- Microsoft® Windows® (95, 98, 2000, ME, NT 4.0, or XP), Macintosh® OS X, or Linux installed
- Computer Operating System CD-ROM on hand
- Internet Explorer® 4.x or Netscape® Navigator® 4.x or higher
- 64 MB RAM (128 MB recommended)
- 10 MB of free hard drive space
- TCP/IP Protocol stack installed
- 10/100 Base-T Network Interface Card (NIC)

WIRELESS

- Pentium® or equivalent and above class machines
- Microsoft® Windows® (98, ME, 2000, or XP) or Macintosh® OS X installed
- Computer Operating System CD-ROM on hand
- Internet Explorer® 4.x or Netscape® Navigator® 4.x or higher
- 64 MB RAM (128 MB recommended)
- 10 MB of free hard drive space
- An available IEEE 802.11b/g/g+ PC adapter



Verizon One User Guide

20. Home Networking

20.3.2 LED Indicators

The LEDs located on the front of **Verizon One** are used to verify the unit's operation and status. Refer to the following chart for details on the LEDs:

LED States and Descriptions

<u>LED</u>	<u>State</u>	<u>Description</u>
POWER	Solid Green	Verizon One power is ON
	OFF	Verizon One power is OFF
	Solid Red	CS POST (Power On Self Test), Failure (not bootable) or Device Malfunction. Note: The Power LED should be red no longer than two seconds after the power on self test passes.
DSL/RDY	Solid Green	Good DSL sync.
	Flashing Green	DSL attempting to sync
	OFF	Verizon One power is OFF.
ETHERNET (E1, E2, E3, E4)	Solid Green	Powered device is connected to one or more of the Ethernet ports (includes devices with wake-on LAN capability where slight voltage is supplied to an Ethernet connection) Note: When using the WAN/E1 port, Ethernet LAN connection is limited to E2, E3, and E4.
	OFF	Communication Subsystem power is OFF, no cable or no powered device is connected to the Ethernet ports.



Verizon One User Guide

20. Home Networking

20.3.2 LED Indicators (*cont'd*)

LED States and Descriptions		
<u>LED</u>	<u>State</u>	<u>Description</u>
WIRELESS	Solid Green	Link Established.
	OFF	Verizon One power is OFF or No Link.
POWER	Solid Green	Verizon One power is ON
	OFF	Verizon One power is OFF
	Solid Red	CS POST (Power On Self Test), Failure (not bootable) or Device Malfunction. Note: The Power LED should be red no longer than two seconds after the power on self test passes.
DSL/RDY	Solid Green	Good DSL sync.
	Flashing Green	DSL attempting to sync
	OFF	Verizon One power is OFF.



Verizon One User Guide

20. Home Networking

20.3.2 LED Indicators (*cont'd*)

LED States and Descriptions		
<u>LED</u>	<u>State</u>	<u>Description</u>
INTERNET	Solid Green	IP connected (the Subsystem has a WAN IP address from IPCP or DHCP, and DSL is up or a static IP address is configured. PPP negotiation has successfully completed (if used) and DSL is up and no traffic is detected.
	Solid Red	Device attempted to become IP connected and failed (no DHCP response, no PPPoE response, PPPoE authentication failed, no IP address from IPCP, etc.).
	OFF	Verizon One power is OFF, Verizon One is in Bridge Mode, or an Internet connection is not present.
LINE IN USE	Solid Blue	Indicates telephone is in use (Off-Hook).
	OFF	Indicates telephone is not in use (On-Hook).



Verizon One User Guide

20. Home Networking

20.3.3 Interface Descriptions

The following chart explains the interface components located on the back of **Verizon One**:

NAME	TYPE	FUNCTION	QUANTITY
Fax (fax, phone, answering machine)	6-pin RJ-11 modular jack	Connects standard telephony equipment to the Verizon One Base Unit. Note: For convenience, this jack has a built-in microfilter for filtering ADSL signals from standard telephone equipment.	1
DSL/Phone	6-pin RJ-11 modular jack	Connects the Verizon One Base Unit to an ADSL equipped telephone jack for DSL/Internet services.	1
Reset	Push Button	Resets the Communications Subsystem settings to factory default settings.	1
Ethernet (E1/WAN, E2, E3, E4)	8-pin RJ-45 modular jack	Connects the Ethernet device(s) to the PC. Note: When using the WAN/E1 port, Ethernet LAN connection is limited to E2, E3, and E4. The WAN/E1 feature is used when installing Verizon One without DSL. The default setting is DSL on WAN/E1 off.	4
12V DC  On/Off	Barrel power connector	12V DC Power Adapter provides the power source for Verizon One .	1
	Power Switch	Controls power on/off of the Base Unit.	1



Verizon One User Guide

20. Home Networking

20.3.4 Installing a Wired Network

Preparation

1. Before you connect your “Wired” network, you must have an Ethernet card installed in each computer that you plan on adding to your network. If your Ethernet card does not auto-negotiate, you must set it to half duplex. Refer to the Ethernet card manufacturer’s instructions for installing and configuring your Ethernet card.

Note: Ethernet Cards can be purchased at www.verizon.net/niccard.

Add Computers to your Wired Network

2. Connect an Ethernet cable from the Ethernet (E2, E3, or E4) jacks marked on the rear panel of the **Verizon One** base station to the

Ethernet port on the computer you are adding. Repeat this step to connect up to two additional PCs to **Verizon One**.

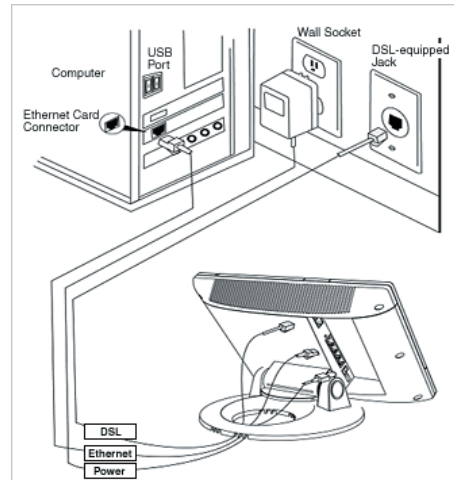

NOTE: You may connect to any of the three Ethernet (E2, E3, or E4) jacks on the rear panel of the **Verizon One** base station as they serve as an Ethernet switch. Your **Verizon One** installation kit contained one (1) Ethernet cable (yellow) for your primary connection. Additional Ethernet cables are not provided and must be purchased separately. The WAN/E1 jack is used for WAN transport when installing **Verizon One** without DSL.



Verizon One User Guide

20. Home Networking

20.3.4 Installing a Wired Network (cont'd)

Verify your Connections

3. Check to see if the Power LED is solid green. If the Power LED is solid green, the Base Unit is powered up.
4. Check to see if the DSL/RDY LED is solid green. If the DSL/RDY LED is solid green, the DSL interface is functioning properly.
5. Check to see if the Ethernet LED is solid green. Solid green indicates that the Ethernet interface is functioning properly.
6. Check to see if the Internet LED is solid green. Solid green indicates that you have established an Internet connection.

Congratulations! You have completed the Wired installation of your **Verizon One** Home Network.

Test Connectivity

Open Internet Explorer or any browser on each computer you have connected to your **Verizon One** Home Network.

Enter <http://verizon.com> into the **Address** field. The Verizon home page will display:

Note: If the Verizon home page does not display, refer to **Verizon One** troubleshooting tips in the Home Networking section of Help & Support at <http://onlinehelp.verizon.net>.

After you have solved the problem, repeat the connectivity test for each computer you are adding to your network.





20. Home Networking

20.3.5 Installing a Wireless Network

Preparation

1. Ensure that an 802.11b/g/g+ wireless network adapter has been installed in each PC on your wireless network.
2. Install the appropriate drivers for your Wireless IEEE802.11b or IEEE802.11g adapter.
3. Turn on Wireless Networking. Do this directly on the **Verizon One** display touch-screen by selecting **Menu**, **Settings**, and then **Wireless**.

Adding Computers to your Wireless Network

4. Configure the Wireless Network Name (called the Service Set ID or SSID) on each PC that will connect wirelessly to **Verizon One**.

IMPORTANT: The Wireless Network Name (SSID) must be the same for both

Verizon One and your PC's wireless network adapter. The default SSID for **Verizon One** is: **Verizon One** followed by the last 4 digits of the unit's serial number (located below the bar code on the bottom of the unit). For example: **Verizon One1234**. You can change the default SSID directly on the **Verizon One** display touch-screen by selecting **Menu**, **Settings**, and then **Wireless**. You must locate and run the utility software provided with your PC's wireless network adapter and enter the SSID. The PC's wireless network adapter must be configured with **Verizon One** before you begin the account set-up and configuration procedures.

NOTE: Client PCs can use any Wireless Fidelity (Wi-Fi) 802.11b/g/g+ certified card to communicate with **Verizon One**. The Wireless card and **Verizon One** must use the same Wired Equivalent Privacy (WEP) security code type. The factory default

for WEP is DISABLED. If you enable WEP, you must ensure that the network setting for your wireless adapter is set to "Must Use Shared Key for WEP" or "Open Wi-Fi." You must ensure that your PC's Wi-Fi adapter is configured properly for whichever network setting you use. You can access the settings in the advanced properties of the wireless network adapter.

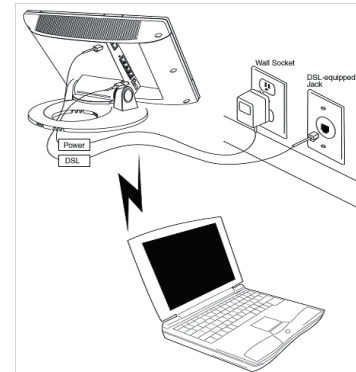



Verizon One User Guide

20. Home Networking

20.3.5 Installing a Wireless Network (cont'd)

Verify your Connections

5. Check to see if the Power LED is solid green. If the Power LED is solid green, the Base Unit is powered up.
6. Check to see if the DSL/RDY LED is solid green. If the DSL/RDY LED is solid green, the DSL interface is functioning properly.
7. Check to see if the Wireless LED is solid Green. This means that the Wireless interface is functioning properly.
8. Check to see if the Internet LED is solid green. Solid green indicates that you have established an Internet connection.

Congratulations! You have completed the Wireless installation of your **Verizon One** Home Network.

Test Connectivity

Open Internet Explorer or another browser on each computer you have connected to your **Verizon One** Home Network.

Enter <http://verizon.com> into the **Address** field. The Verizon home page will display.

Note: If the Verizon home page does not display, refer to **Verizon One** troubleshooting tips in the Home Networking section of Help & Support at <http://onlinehelp.verizon.net>.



Verizon One User Guide

20. Home Networking

20.3.6 Installing Both a Wired and Wireless Network Simultaneously

Verizon One supports simultaneous use of Wired and Wireless network connections. The following instructions explain how to install **Verizon One** for simultaneous use of Wired and Wireless connections:

- To add Wired PCs follow the steps outlined in Section 20.3.4
- To Add Wireless PCs follow the steps outlined in Section 20.3.5

20.4 Accessing Configuration Settings

The **Verizon One** Communications Subsystem allows you to make changes to advanced features such as routing configurations, and firewall settings. Commonly accessed features are listed below in the sections to follow.

Note: As your **Verizon One** contains a **Westell VersaLink™ Gateway** (combination modem and wireless router), you will see Westell Configuration Screens while accessing Advanced Features for the **Verizon One** Communications Subsystem.

Tip: For additional details on more advanced features, you may access the complete **Westell VersaLink™ 327W Gateway** User Guide (Sections 10 - 16). To access this User Guide, visit

<http://onlinehelp.verizon.net>, and then select **Home Networking** from the available Help topics. Choose the link for **Wireless Home Networking** from the topics listed. Then select **Download User Manual** underneath the **Westell VersaLink™ 327W Gateway**.



Verizon One User Guide

20. Home Networking

20.4 Accessing Configuration Settings (cont'd)

Connecting to the Advanced Features Configuration Tool

Open your Web browser and type <http://192.168.1.1> in the browser's address window, and then press **Enter** on your keyboard. You will see the following screen (assuming you have completed the CD Registration):



Connection Overview	Displays your DSL connection rate.
Connection Name	This Connection Name is from the connection profile that you established in section 7.
PPP Status	UP = PPP session established. DOWN = No PPP session established.
Connect/Disconnect	CONNECT = Establish a PPP session. DISCONNECT = Disconnect a PPP session.
Profile Editor	This allows you to make changes to the profile that you created in section 7.



Verizon One User Guide

20. Home Networking

20.4 Accessing Configuration Settings (cont'd)

Navigating through the Advanced Configuration Tool

As you navigate through the various screens of the **Verizon One** Communications Subsystem, the name of the active page that you have selected will appear in the upper-left side of the screen, as shown below. Please note that the actual values may differ from the values displayed in the screens:



Administrative Password

The following settings will be displayed if you select **Administrative Password**

from the **Maintenance** menu. After you enter your data into the appropriate settings, click **Change**:

NOTE: If you are not an authorized user and do not know the Administrative ID and password, you will not be able to change the values (**Verizon One** cannot be configured unless the user is logged in). Contact your network administrator for further instructions.

Enter Administrative Name

Note: This changes the Systems Administrator password - not the PPP password.

Type the name of your network administrator.

Note: Same as VOL Primary User ID.

Enter Administrative Password

Type your network administrator's password.

Note: Same as VOL Primary Password.

Verify Administrative Password

Re-type your network administrator's password.



Verizon One User Guide

20. Home Networking

20.4 Accessing Configuration Settings (cont'd)

Wireless Configuration

The following fields will be displayed if you select **Wireless** from the **Configuration** menu:

IMPORTANT: If you are connecting to **Verizon One** via a wireless network adapter, the service set ID (SSID) must be the same for both **Verizon One** and your PC's wireless network adapter. The default SSID for **Verizon One** is the serial number of the unit (located below the bar code on the bottom of the Base Unit). Locate and run the utility software provided with your PC's wireless network adapter and enter the SSID value. The PC's wireless network adapter must be configured with the

SSID (in order to communicate with **Verizon One**) before you begin **Verizon One's** account set-up and configuration procedures. For privacy, you may change the Network Name (SSID) value in the Wireless Configuration screen to your desired value.

NOTE: Client PCs can use any Wireless Fidelity (Wi-Fi) 802.11b/g/g+ certified card to communicate with **Verizon One**. The Wireless card and **Verizon One** must use the same Wired Equivalent Privacy (WEP) security code type. The factory default for WEP is DISABLED. If you enable WEP, you must ensure the network setting for your wireless adapter is set to "Must Use Shared Key for WEP" or "Open Wi-Fi." You must ensure that your PC's Wi-Fi adapter is configured properly for whichever network setting you use. You can access the settings in the advanced properties of the wireless network adapter.



Verizon One User Guide

20. Home Networking

20.4 Accessing Configuration Settings (cont'd)

To select a network setting, click the drop-down arrow at the field labeled **Authentication Type**, and then select either **Open System** or **Shared Key**. If you change any settings in this screen, you must click the **Save** button to ensure that the settings take effect:

The screenshot shows the Westell Wireless Configuration interface. At the top, there is a navigation bar with links for Home, Status, Configuration, Maintenance, Troubleshooting, and Help. Below this is a sub-header for 'Wireless Configuration'. The main content area is titled 'Wireless Configuration' and contains several sections:

- Wireless Operation:** Includes fields for Wireless Operation (set to Enabled), Network Name (SSID) (0001), Channel (6), Mode (Mixed), and 4x Support (Disabled).
- Advanced Configuration:** A section with an 'edit' button.
- Privacy Settings:** This section includes:
 - Authentication Type: Open System
 - WEP Security: Disabled
 - Key Select: Key 1
 - Key 1, Key 2, Key 3, and Key 4: Each has a text input field and a '64 bit' dropdown menu.
 - A note: '*WEP keys are 5, 13, or 29 text digits or 10, 26, or 88 hexadecimal digits for 64, 128, or 256 bit keys respectively.'
 - Key Mapping Table: A section with an 'edit' button.
 - Hide SSID: Disabled
 - MAC Address Filtering: Disabled
 - MAC Filter Table: A section with an 'edit' button.
- Buttons:** 'save' and 'reset' buttons are located at the bottom of the configuration area.



Verizon One User Guide

20. Home Networking

20.4 Accessing Configuration Settings (cont'd)

Wireless Configuration Information

Wireless Operation	Factory Default = Enabled. When Disabled, no stations will be able to connect to Verizon One .
Network Name (SSID)	This string, (32 characters or less) is the name associated with the AP. To connect to the AP, the SSID on a Station card must match the SSID on the AP card or be set to "ANY."
Channel	The AP transmits and receives data on this channel. The number of channels to choose from is pre-programmed into the AP card. Station cards do not have to be set to the same channel as the AP; the Stations scan all channels, and look for an AP to connect to.
Mode	This setting allows the Station to communicate with Verizon One . Possible Responses: Mixed: Station using any of the 802.11b, 802.11b+, and 802.11g rates can communicate with Verizon One . 11b only: Communication with Verizon One is limited to 802.11b 11b+: Stations using any of the 802.11b and 802.11b+ rates can communicate with Verizon One 11g only: Communication with Verizon One is limited to 802.11g.
4x Support	Factory Default = Disabled. When selected, this enables/disables the 4X option. If enabled, 4X support provides additional algorithms for increased throughput. The station cards must also support this option.
Advanced Configuration edit button	Selecting this button allows access to the Wireless Advanced Configuration settings.



20. Home Networking

20.4 Accessing Configuration Settings (*cont'd*)

Privacy Settings

Authentication Type	<p>Factory Default = Open System.</p> <p>Possible Response: Open System: Open System authentication is the default selection.</p> <p>Shared Key: To use Shared Key authentication, WEP must be enabled, and a valid WEP key must be present. Enabling WEP does not force the use of Shared Key authentication. It is permissible to have WEP enabled and still use Open System authentication.</p>
WEP Security WEP Security	<p>Factory Default = Disabled.</p> <p>The AP card supports 64-bit, 128-bit, or 256-bit WEP encryption. If WEP is Disabled, any station can connect to the AP (as long as its SSID matches the AP SSID).</p>
WEP (Wired Equivalent Privacy)	<p>If WEP is enabled, the risk of someone nearby accessing the AP is minimized.</p>
Key Select	<p>If selected, the WEP Key is treated as a string of text characters, and the number of characters must be either 5 (for 64-bit encryption) or 13 (for 128-bit encryption) or 29 (for 256-bit encryption). If not selected, the WEP key is treated as a string of hexadecimal characters, and the number of characters must be either 10 (for 64-bit encryption), 26 (for 128-bit encryption), or 58 (for 256-bit encryption). The only allowable hexadecimal characters are 0-9 and A-F.</p> <p>Note: The WEP key must be the same value and type for both Verizon One and the wireless network adapter. "Pass Phrase" is not the same as "text" and should not be used.</p>



20. Home Networking

20.4 Accessing Configuration Settings (*cont'd*)

Privacy Settings (*cont'd*)

Key Mapping Table button	Selecting this button will allow access to the Wireless Key Mappings settings.
Hide SSID	Factory Default = Disabled. If Enabled, Verizon One will not broadcast the SSID. Stations must configure the SSID to match the Network Name (SSID) to connect to Verizon One .
MAC Address Filtering	Factory Default = Disabled. If Enabled, only the stations in the MAC Filter Table can connect to Verizon One .
MAC Filter Table button	Selecting this button allows access to the Wireless MAC Address Filter Table.



Verizon One User Guide

20. Home Networking

20.4 Accessing Configuration Settings (cont'd)

Wireless Key Mappings

The following screen will be displayed if you click the **Edit** button adjacent to the **Key Mapping Table** in the **Wireless Configuration** screen:

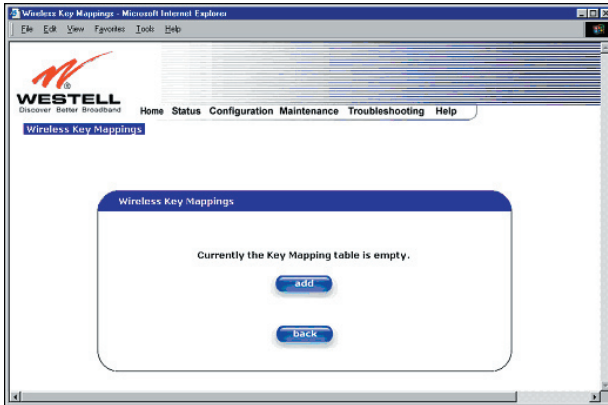

WEP Key	Select Enable if you want this WEP key enabled for the listed MAC Address.
MAC Address	The MAC Address assigned to the Station for which you want to assign a WEP key.
Key Length	The number of bits the encryption is going to use for WEP. The options are 64, 128, or 256 bits.
Key Value	The WEP key to be used for this station.



Verizon One User Guide

20. Home Networking

20.4 Accessing Configuration Settings (cont'd)

Firewall Configuration

The following settings will be displayed if you select **Firewall** from the **Configuration** menu:



Security Level

- High High security level only allows basic Internet functionality. Only Mail, News, Web, FTP, and IPSEC are allowed. All other traffic is prohibited.
- Medium Factory Default = MEDIUM. Like High security, Medium security only allows basic Internet functionality by default. However, Medium security allows customization through NAT configuration so that you can enable the traffic that you want to pass.
- Low The Low security setting will allow all traffic except for known attacks. With Low security, **Verizon One** is visible to other computers on the Internet.
- None Firewall is disabled (All traffic is passed).
- Custom Custom is an advanced configuration option that allows you to edit the firewall configuration directly. **Note:** only the most advanced users should try this.

Remote Logging



- Enable Factory Default = Disabled. If Enabled, **Verizon One** will send firewall logs to a syslog server.
- Remote IP Address The IP address of the syslog server machine to which the diagnostics logs are to be sent.



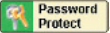

Verizon One User Guide

20. Home Networking

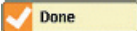
20.5 Authenticate User

1. Select **My Connection** .
2. Select  to enter your User Name and Password. (This is usually your **Verizon Online** User Name and Password).
3. Select  to sign into network.

20.6 Password Protection

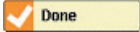
1. Open Settings.
2. Select **Home Networking** .
3. If your password protection is ON:
 - Select  to enter your User Name and Password. (This is usually your **Verizon Online** User Name and Password.)
 - Select  to sign into network.

If your password protection is OFF, you will go directly to the Home Networking Screen.



Verizon One User Guide

20. Home Networking

20.7 Configure Wireless Settings

1. Select .
2. If you are in Application Mode:

Wireless Network Settings

- Select  or .
- Select .



Wireless Security Settings

- Select  or .
- Select .

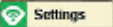

3. If you are in Client Mode:

- Select .

20.7.1 Setup Wireless Network

1. If you are in Application Mode, select Wireless Network .
2. Select  to enter the Wireless Network Name (SSID).
3. Select the checkbox to refrain from broadcasting your server name.
4. Be sure the Mode G Band and B Band checkboxes are checked.

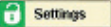
20.7.2 Setup Wireless Security

1. If you are in Application Mode, select Wireless Security .
2. Select  to enter a Password. (5-character phrase or 10-character key).
3. Choose Encryption Type
 - WEP
 - WPA-PSK

Note: Changing the Encryption Type will require you to enter a new Password.

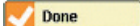
4. Choose Encryption Strength
 - Low Encryption
 - Medium Encryption
 - High Encryption
5. Select  to save your settings.



Verizon One User Guide

20. Home Networking

20.8 Manage Security

Select Security .

20.8.1 Change Firewall

1. Select Firewall .

2. Choose Firewall level:

- Off
- Low
- Medium
- High

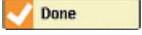
3. Select  to save your settings.

20.8.2 Add Services

1. Select Services .

2. Select .

3. Select  or the entry field to enter:

- Name (ex: Personal, Anonymous, User Name)
- Start Port and End Port
- Host Name or IP Address
(To find: Go to Connect to...)
- Host Port

4. Select  to select a Service or Client from a pop-up list.

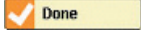
5. Select  to save your settings.

20.8.3 Manage Services

1. Select Services .

2. Select .

3. Select  or the entry field to enter:

- Name (ex: Personal, Anonymous, User Name)
- Start Port and End Port
- Host Name or IP Address
(To find: Go to Connect to...)
- Host Port

4. Select  to select a Service or Client from a pop-up list

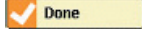
5. Select  to save your settings.





Verizon One User Guide

20. Home Networking



20.8.4 View Services

1. Select Services .
2. Select one of the Services listed.
3. The Service information will appear.



20.8.5 View Clients

1. Select Clients .
2. A list of Clients will appear with wired  or wireless  icons indicating its network capabilities.



20.9 Setup My Connection

1. Select My Connection .
2. **Verizon One** will display whether you are connected through:
 - Verizon DSL
 - FiOS
3. Select  to return to the previous screen.

20.9.1 Setup FiOS Connection

1. On the next screen, read the note and select .
2. Follow instructions for connecting network cable to **Verizon One**.
3. Select  to return to the previous screen.

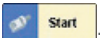
20.9.2 Setup DSL Connection

1. Select Connect Using DSL .
2. On the next screen, read the note and select .
3. Follow instructions for disconnecting network cable and connecting DSL phone line to **Verizon One**.
4. Select  to return to the previous screen.



Verizon One User Guide

21. Technical Support

21.1 Getting Help

21.1.1 Touch-Screen Help

There are multiple ways to get help with **Verizon One**:

- Touch  at the top of any screen to find instructions and helpful tips for that screen.
- From the **Home** screen, access the Menu, and then the **Help** icon – to locate general instructions and FAQs.

21.1.2 Help with Your DSL Service

Your PC

You must ensure that your computer meets minimum system requirements. Otherwise, your DSL service will not work properly. Visit our online tool at: <http://www.verizon.net/checkmypc> for instructions.

Your DSL Service Ready Date

By following the **Welcome** screens on the **Verizon One** display (see section 7.2) **Verizon One** will automatically check for an active DSL connection and notify you when your Service Ready Date has arrived. However, if you would like to find out when your service will be activated, visit: www.verizon.com/dslorderstatus.

DSL Installation

Once **Verizon One** has detected an active DSL Connection and notified you that your DSL Service Ready Date has arrived, **Verizon One** will instruct you to insert the DSL Installation CD to complete your DSL registration. Inserting the CD into your primary computer will then provide Step-by-Step Instructions for installing DSL Filters in your home, and assist you with your account set-up.

The Verizon Online Support Center

Once you install your CD software, click the “Verizon Online Support Center” icon (the question mark on your desktop). It works even when your computer is offline.

Go to <http://onlinehelp.verizon.net> if you have an active Internet connection.



Verizon One User Guide

21. Technical Support

21.1.3 Helpful Web Sites

- About **Verizon One**:
www.verizon.com/verizon-one
- Verizon Online DSL Start Page:
<http://dslstart.verizon.net>
- Verizon Online DSL with MSN Premium Start Page:
www.verizon.msn.com
- Verizon Online DSL Help & Support:
<http://onlinehelp.verizon.net>
- Verizon Products and Services:
www.verizon.com
- More about **iobi Home**:
<http://www.verizon.com/iobihome>

21.1.4 Important Troubleshooting Tips

Trouble Establishing an Internet Connection?

1. Reboot the modem within **Verizon One** by holding down the “1” numeric hard key and “Volume Up” hard key at the same time – for 3 seconds.
2. Reboot your computer.

Trouble with **Verizon One** or the Touch-Screen Display?

Use the black power switch on the back of the Base Unit to turn **Verizon One** OFF and then back ON again. This may help solve the problem.

21.1.5 Contact Us

The **Verizon One** DSL Customer Support team is available 24/7 at 1-800-567-6789. The FiOS Customer

Service Center takes all support calls for customers with FiOS and can be reached at 888-553-1555.

21.1.6 Automatic Software Updates

Verizon One provides automatic software updates from Verizon to ensure that you have the most current features and enhancements. Updates are performed during periods when **Verizon One** is not in use, and does not require any interaction from you, the user. After an update has been downloaded, **Verizon One** will wait for a period of inactivity before a reset function is performed, enabling the new enhancements to become active. You can view a list of all software updates, including date and time of each update, within the **Settings** menu on the **Verizon One** display.



Verizon One User Guide

21. Technical Support

21.1.7 Verizon One Customer Notifications

Verizon One puts the power and intelligence of the Verizon network at your fingertips. Receive messages about your **Verizon One** and Verizon Online DSL service on the Verizon Messages screen. A small check mark icon will appear at the top of your **Home** screen when a new message has arrived. You can access the new message by touching the icon, or selecting **Verizon Messages** from the Menu.